

TV INTERFACE

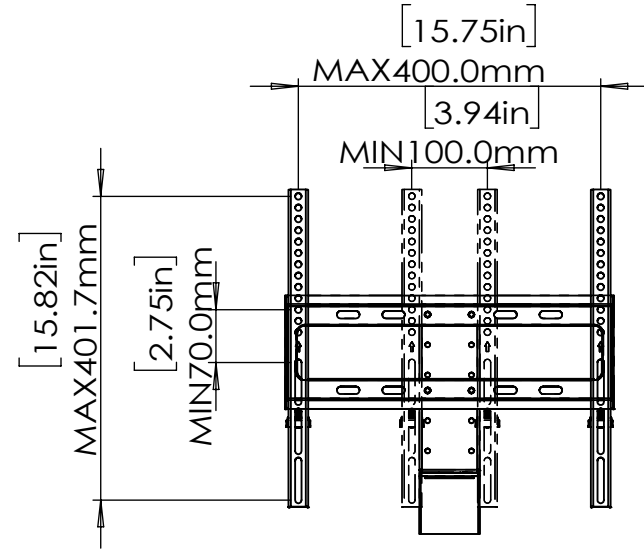

ERTSM2-01B

The information and designs contained in this document are confidential and the proprietary property of BESTERGO, Inc neither the design nor any information contained in this drawing may be reproduced, used, or disclosed to others without the express written permission of BESTERGO, Inc.

3-D View

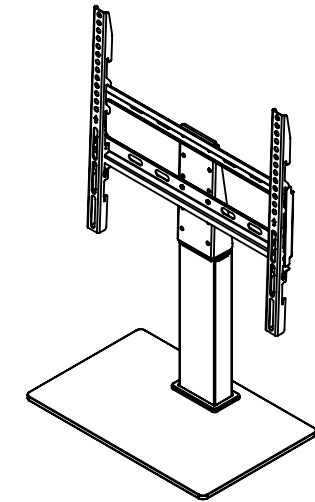

FRONT VIEW

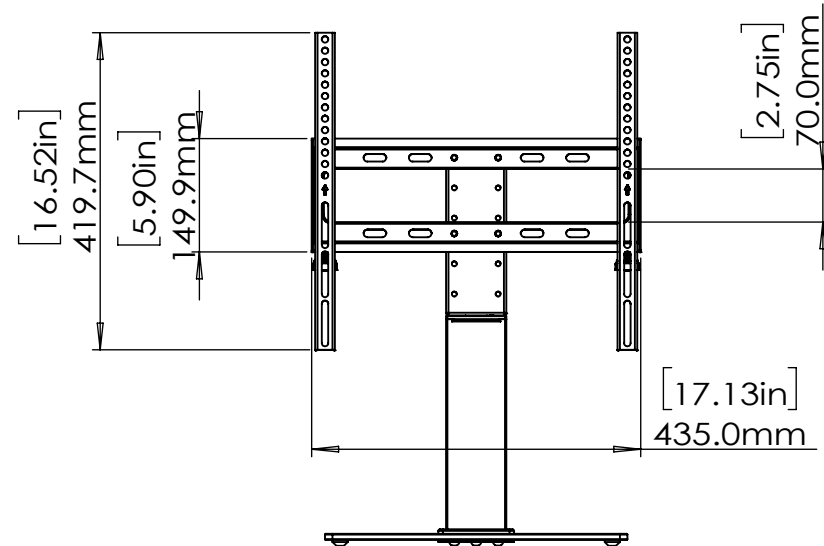

TOP VIEW

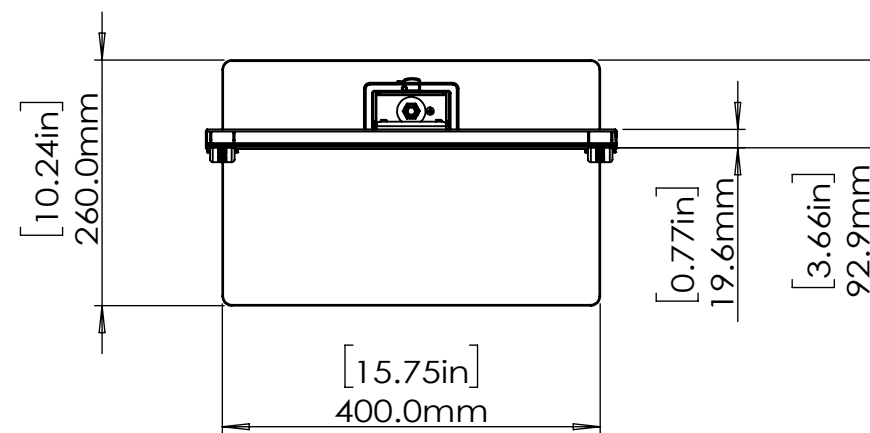

SIDE VIEW

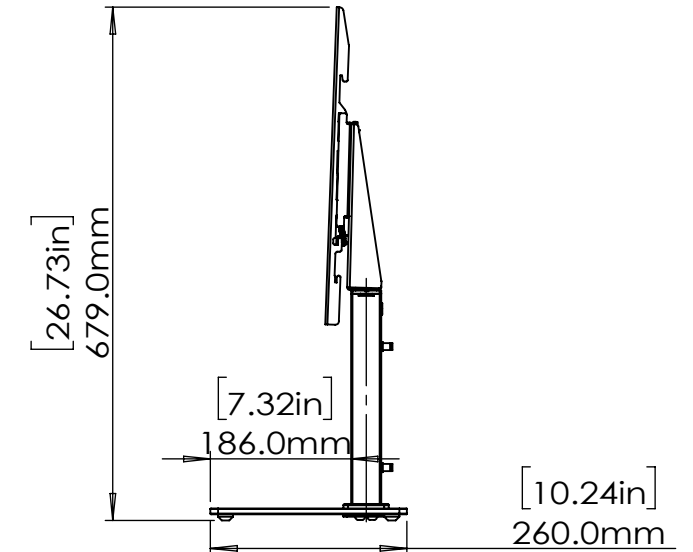

Height Adjustments – TV Mounting Plate

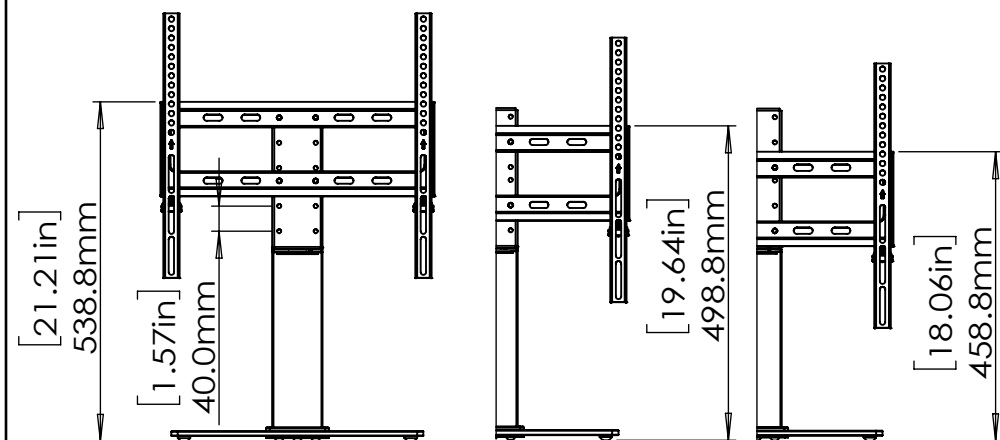

Height Adjustments TV Brackets

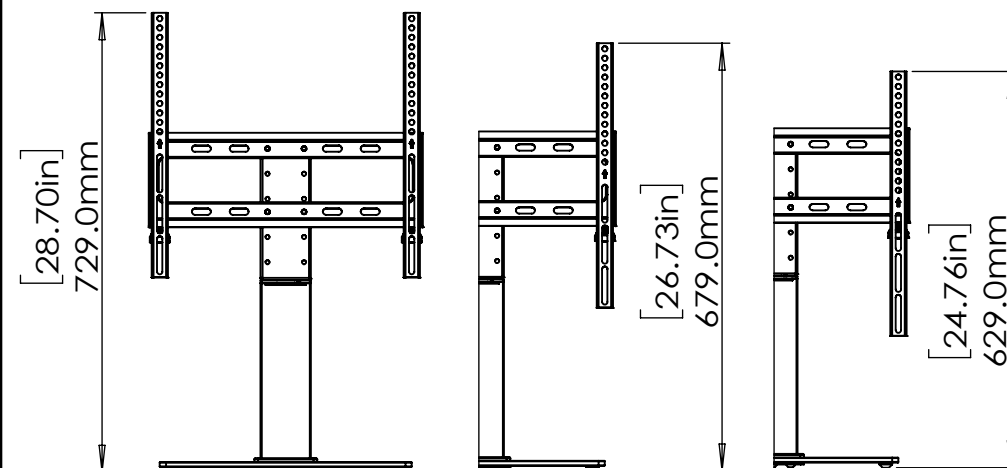

TOP VIEW SWIVEL

