

TV INTERFACE

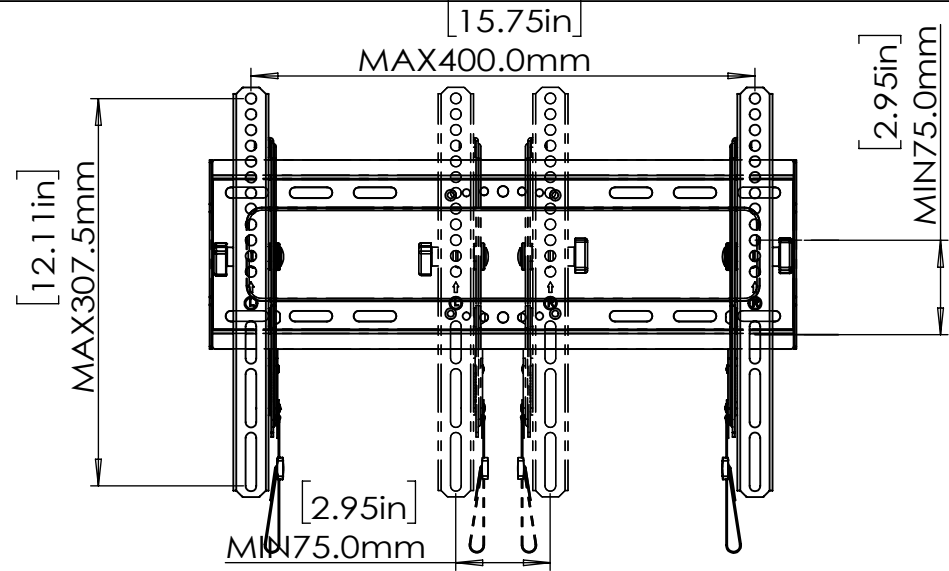

ERMTM2-01B

The information and designs contained in this document are confidential and the proprietary property of BESTERGO, Inc neither the design nor any information contained in this drawing may be reproduced, used, or disclosed to others without the express written permission of BESTERGO, Inc.

3-D View

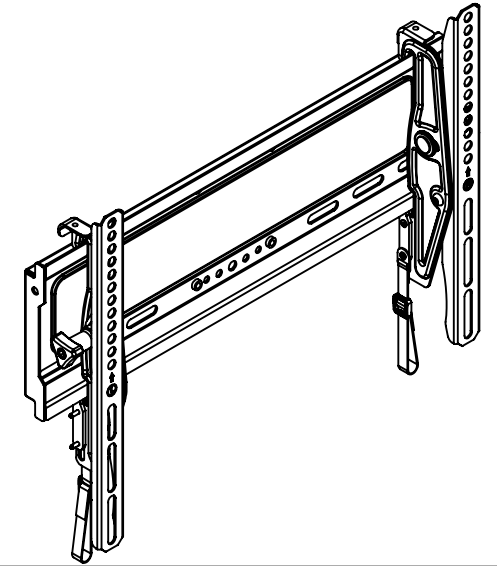

WALL PLATE

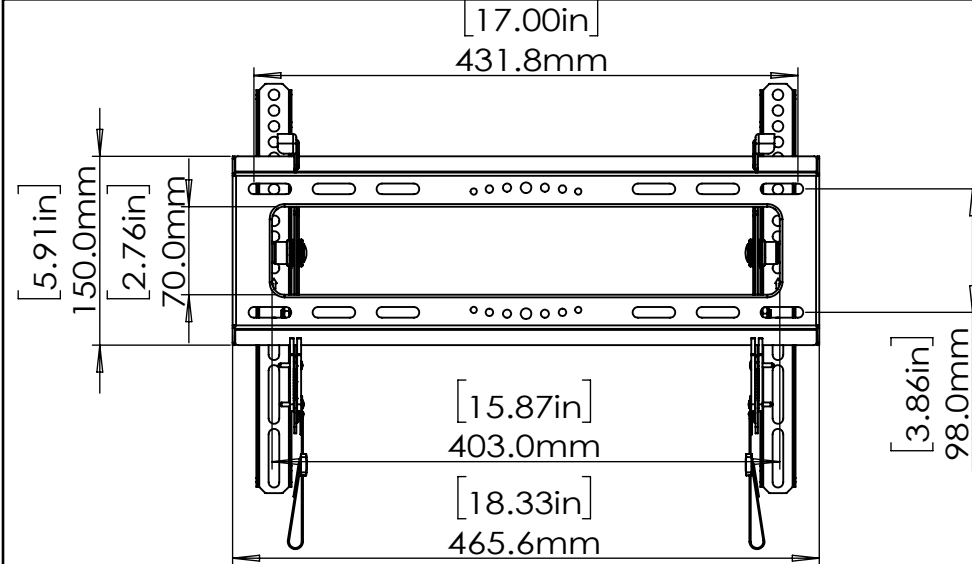

FRONT VIEW

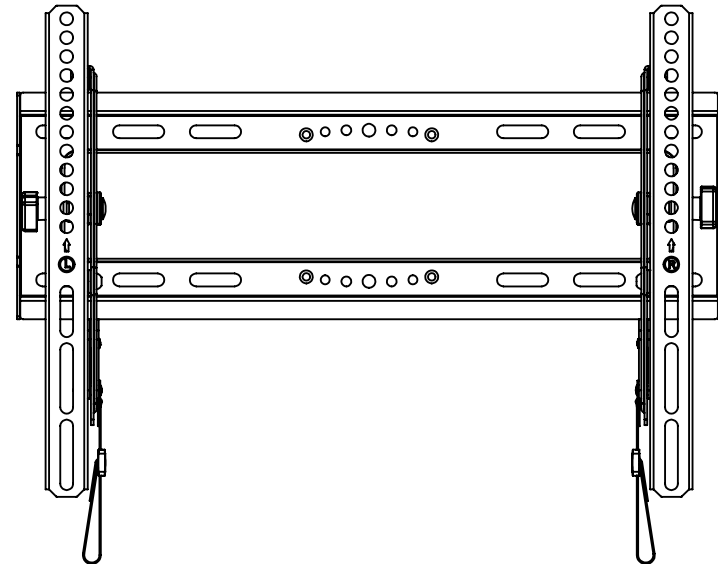

SIDE VIEW - TILTING

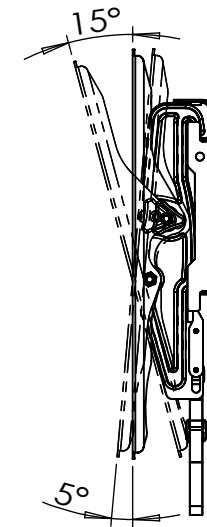

FULLY ASSEMBLED MOUNT

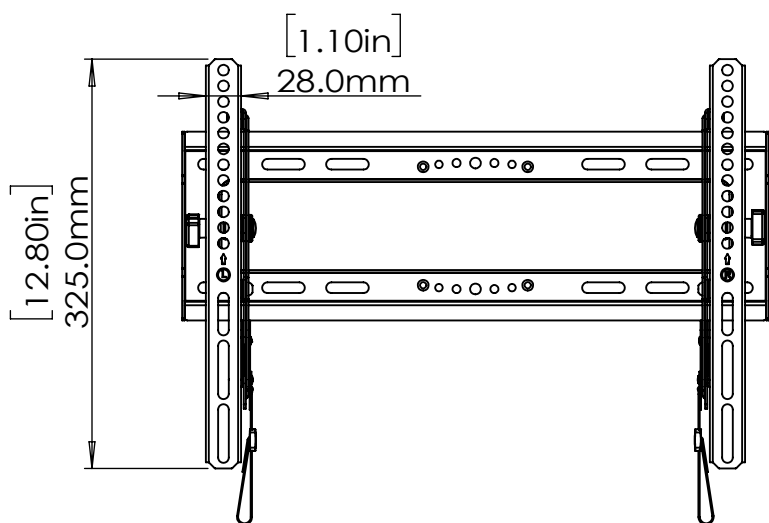

TOP VIEW

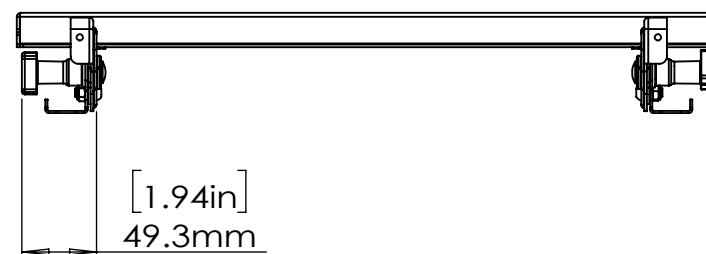

SIDE VIEW

