



TV Wall Mount Instruction Manual

V1.0

English pages 02–14

French pages 15–27

Spanish pages 28–40

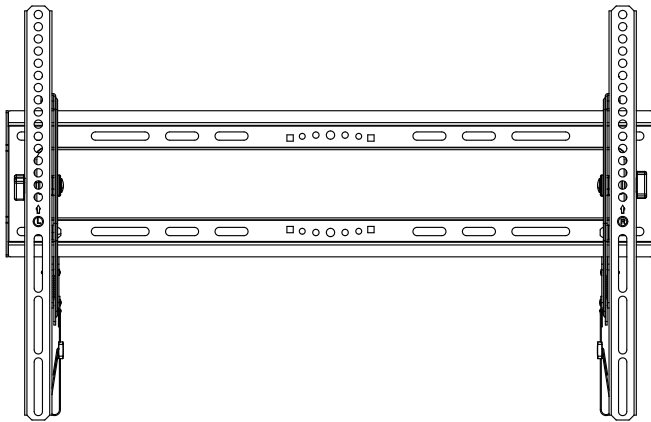

Model: ERMTL1-01B

THANK YOU FOR CHOOSING THIS ERGOAV PRODUCT!

At ErgoAV, we want to add value to your AV experience by providing the highest quality products and services in the industry. If you have any concerns or comments, please contact us.

ErgoAV Customer Care

Phone (877) 419-7832 M-F 8am to 8pm CST

email: support@ergoav.com

website: www.ergoav.com

address: 9501 Louisiana Ave N, #200 Brooklyn Park, MN 55445

IMPORTANT SAFETY INFORMATION

T Q b WU Please carefully read all instructions before attempting installation. If you do not understand the instructions or have any concerns or questions, please contact our Technical Support line at (877) 419-7832 or customer service at support@ergoav.com.

CAUTION: Use with products heavier than the maximum weights indicated may result in instability causing possible injury.

- Do not use this product for any purpose. Do not exceed weight capacity. We are not liable for damage or injury caused by improper mounting, incorrect assembly or inappropriate use.
- This product is designed for use in wood stud, and solid concrete walls. – DO NOT install into drywall alone.
- The wall must be capable of supporting four times the weight of the TV and mount combined.
- Use this mounting system only for its intended use as described in these instructions. Do not use attachments not recommended by the manufacturer.
- Do not use outdoors.
- Route cords and cables properly to avoid mechanical damage.
- SAVE THESE INSTRUCTIONS.

Weight Restrictions



If your TV weighs more, do not use this product.

! WARNING

DO NOT exceed the maximum weight indicated. This mounting system is intended for use only within the maximum weights indicated. Use with products heavier than the maximum weights indicated may result in failure of the mount and its accessories, causing damage and or injury.

Check the VESA Pattern of Your TV before the Installation

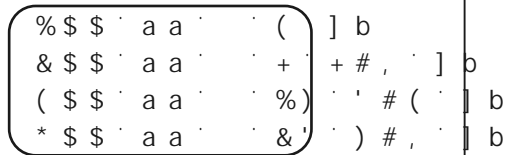
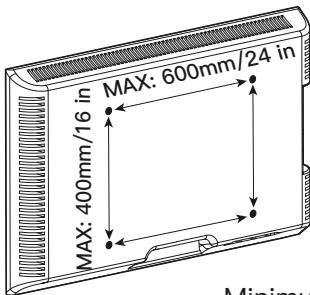

Minimum VESA pattern: 200mm/8 in (W)x100mm/4 in (H)

If your TV VESA is greater than 600x400 mm/24x16 in or less than VESA 200x100mm/8x4 in, this mount is NOT compatible.

If this mount is NOT compatible, please contact our Technical Support line at (877) 419-7832 or customer service at support@ergoav.com.

Tools Needed (Not Included)



Stud Finder



Awl



Tape Measure



Pencil



Electric Drill

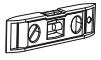

Level



7/32 in (5.5mm)
Wood Drill



1/2 in (13mm)
Socket Wrench



Phillips
Screwdriver

1 b y x y x " i n " w n i w y



3/8 in (10mm)
Concrete Drill



Hammer

Verify Your Wall Construction

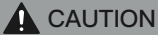

CAUTION

DO NOT
install into
drywall alone

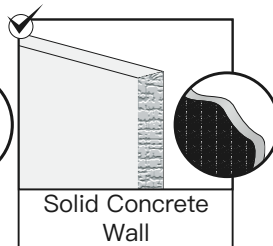
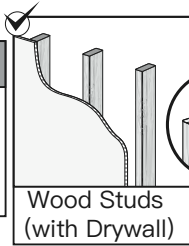

If you are not sure of the wall construction, please contact our Technical Support line at (877) 419-7832 or customer service at support@ergoav.com.

Supplied Parts and Hardware

- ⚠ Warning:** This product contains small items that could be a choking hazard if swallowed. Before starting assembly, verify all parts are included and undamaged. Do not use damaged or defective parts. If you require replacement parts, please contact our Technical Support line at (877) 419-7832 or customer service at support@ergoav.com
- Please note: Not all hardware included in this package will be used.

Supplied Parts and Hardware for Step 1

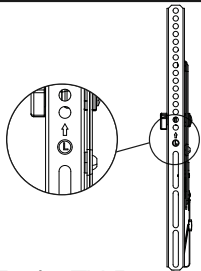

Right TV Bracket

02 x1

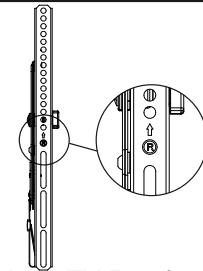

Left TV Bracket

03 x1

Spacers

NOTE: The spacers are shown in actual size.

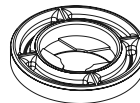

L2.5mm

F1 x8

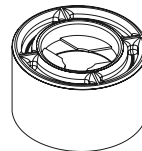

L10mm

F2 x4

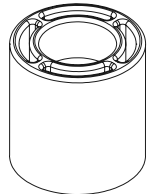

L22mm

F3 x4

Washer

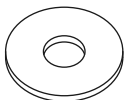

M4/M5

B1 x4

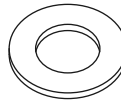

M6/M8

B2 x4

TV Bolts

NOTE: The bolts are shown in actual size

M4

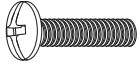

M4x12mm
C1 x4

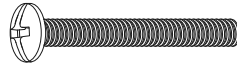

M4x30mm
C2 x4

M6

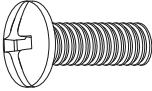

M6x15mm
D1 x4

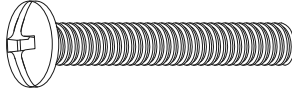

M6x35mm
D2 x4

M8

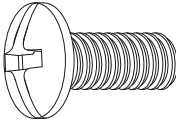

M8x15mm
E1 x4

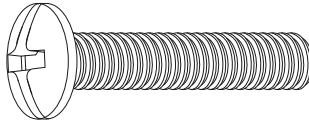

M8x35mm
E2 x4

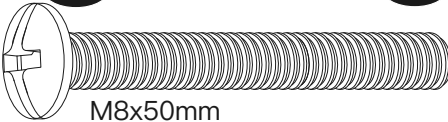

M8x50mm
E3 x4

Step 1 Secure the TV Brackets to the TV

Select TV Bolts

C b ` m ` c b Y ` V c ` h ` g] n Y ` h g ` m c i f ` H J "

M4 M6 M8

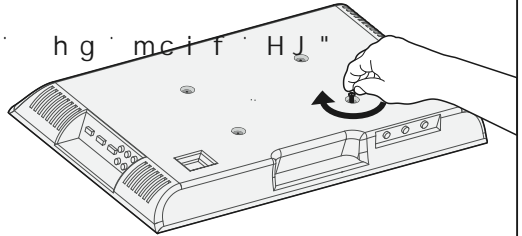
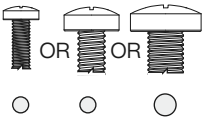

Bolt length: Verify adequate thread engagement with bolts or bolts/spacers combination. We recommend thread engagement by at least 5 turns.

- Too short will not hold the TV.
- Too long will damage the TV.

Note: Please do not over tighten the TV bolts to avoid damaging your TV.

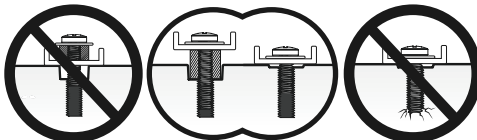

Too short Correct Too long

Please Note: When using the spacers it is important to note that they can be used in a i ` h] ! ` U m Y f g ` f l a Y U b] b [` g h U W _ Y X £ ¤ U ¢ ¤] ¤ [c i \ & K j Y c the TV bolts or spacers, please contact our Technical Support line at (877) 419-7832 or customer service at support@ergoav.com.

Parts Needed if You Have a TV as Shown Below

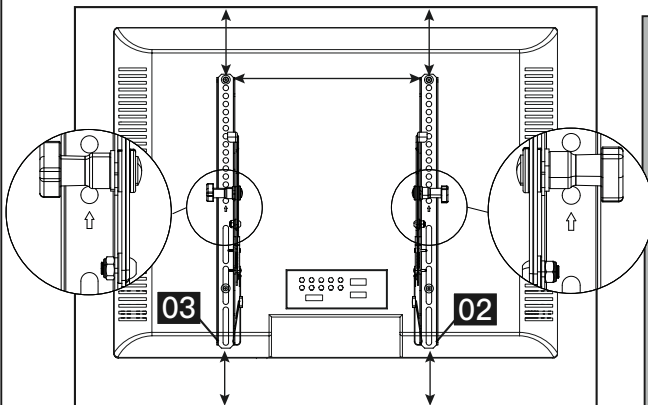
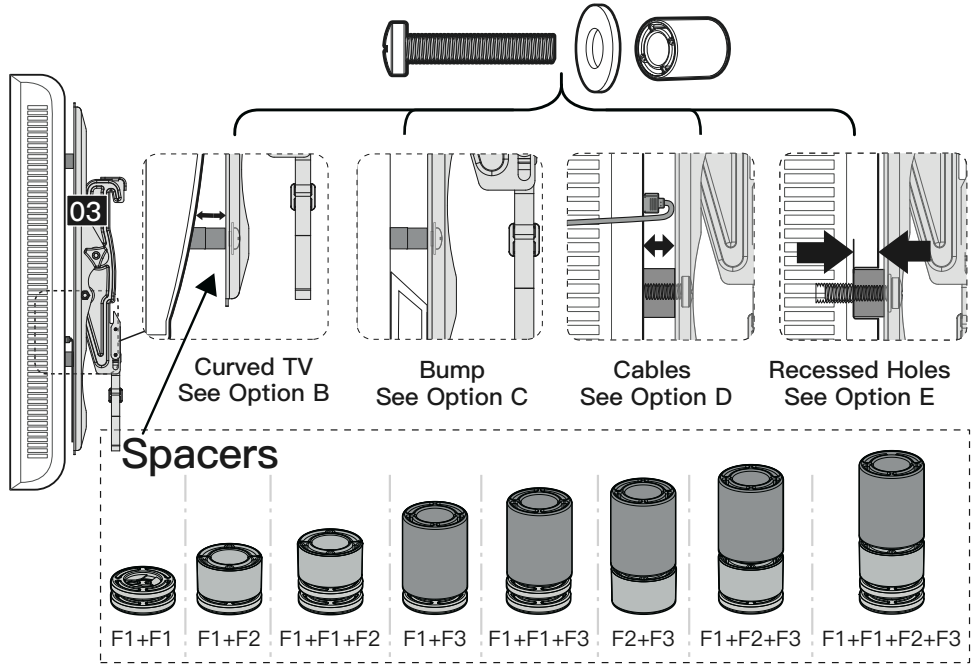

⚠ CAUTION: When attaching the TV brackets to the back of the TV, ensure the Up Arrows are pointing to the top of the TV and are equally centered on the back of the TV.

⚠ PLEASE NOTE: The bolt hole locations on your TV may vary in accordance of the manufacturers design of the TV. We are only illustrating possible locations of the bolt holes.

Option A (For Flat Back TV)

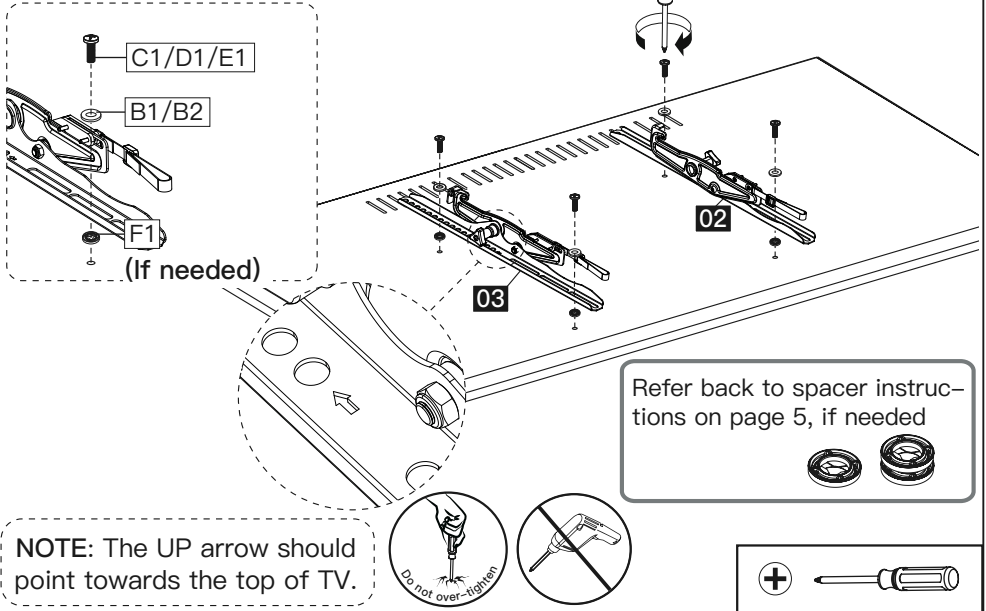

Option B (For Round Back TV)

Spacers must be tall enough so that the curve on the back of the TV will not interfere with the mounting plate.

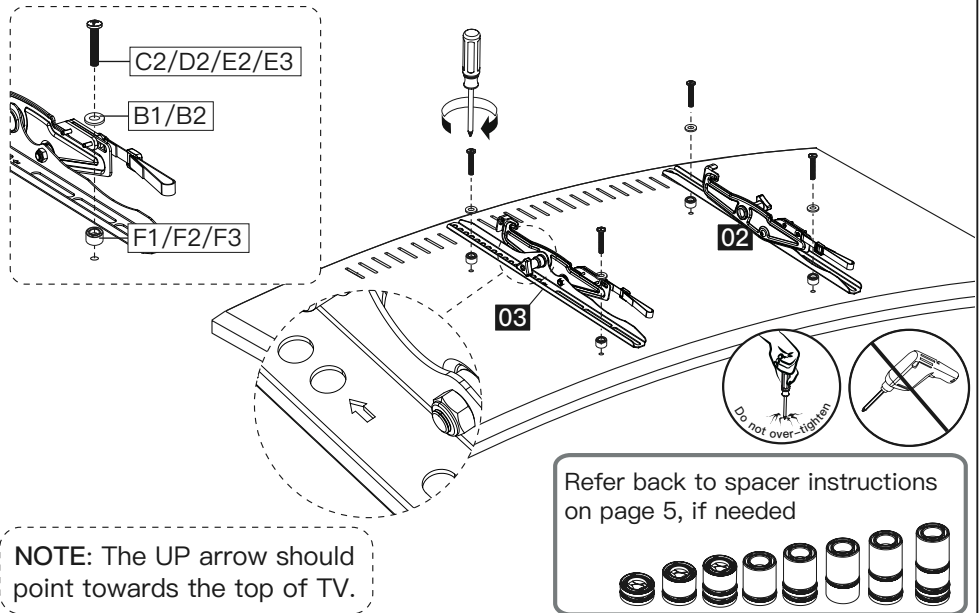

Option C (For TV with A “Bump”)

G d U W Y f g a i g h V Y h U Y b c i [\ GAP) on bump.

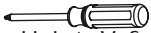
⊕  Phillips Screwdriver (Not Included)

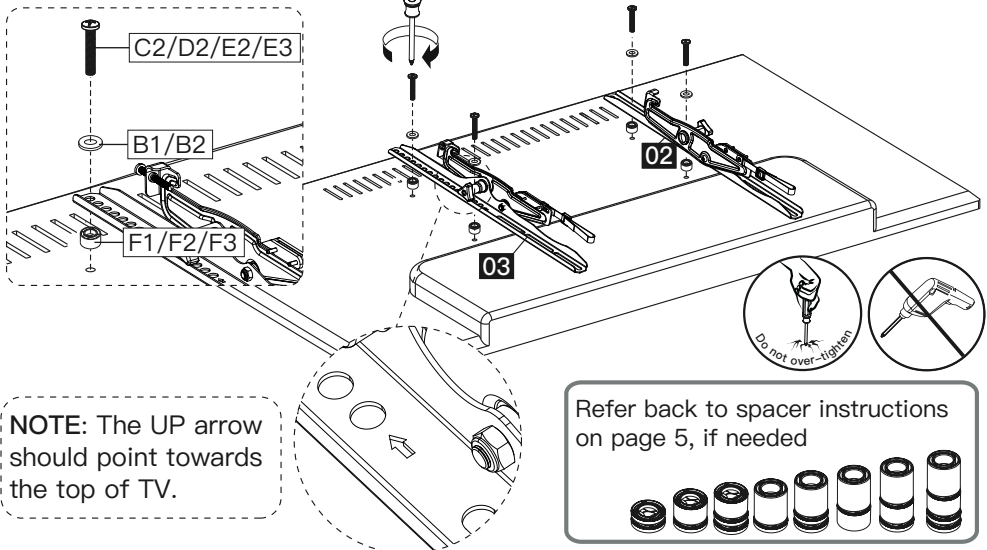

Option D (for TV with Cable Interference)

: c f W U V Y] b h Y f Z Y f Y b W Y z i g Y create extra space between the TV and TV brackets.

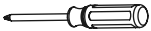
⊕  Phillips Screwdriver (Not Included)

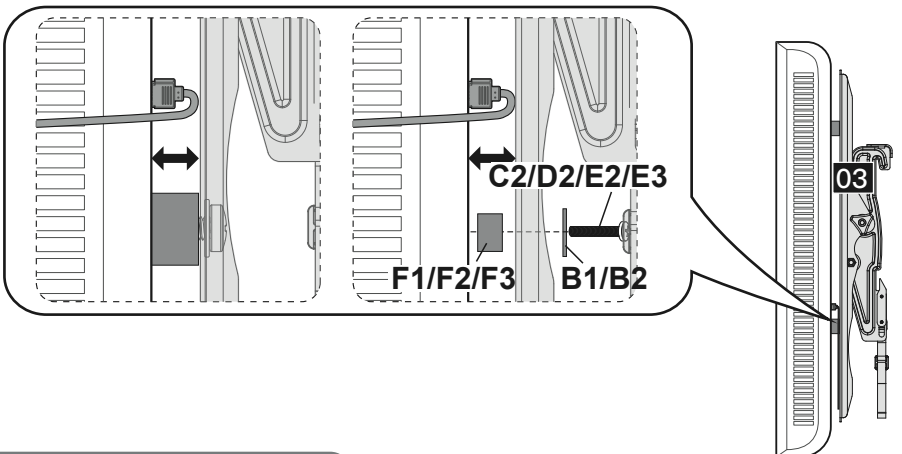

Refer back to spacer instructions on page 5, if needed



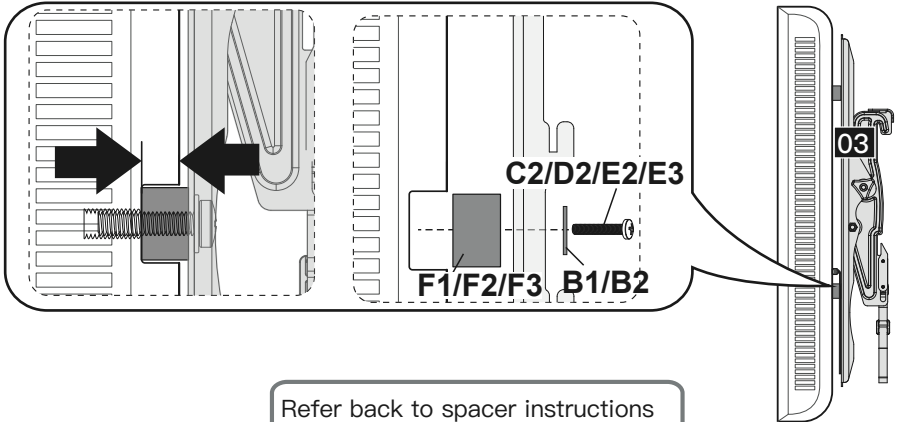
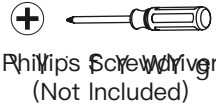

Option E (For Recessed Holes)

Push the TV Brackets back of the TV so that the TV Brackets are as close to the TV as possible.

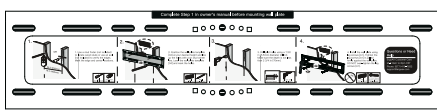
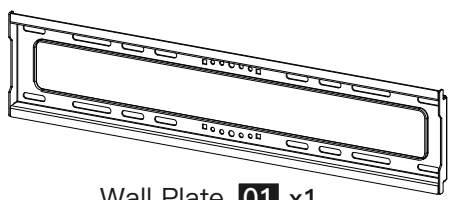

Refer back to spacer instructions on page 5, if needed

Supplied Parts and Hardware for Step 2



Note: The lag screw is shown in actual size

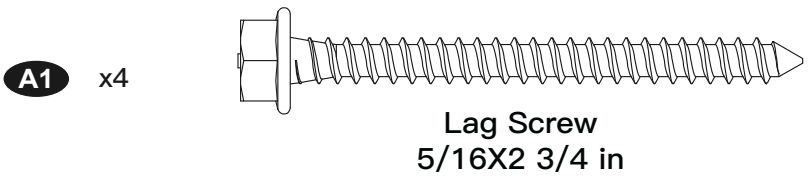

A2

x4

Wall Anchor 10X60mm

! CAUTION!

This anchor is for concrete walls ONLY. DO NOT use them in drywall or wood studs.

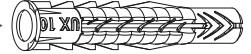

Step 2 Attach the Wall Plate [01] to the Wall

For wood stud installation, follow STEP 2A

For concrete installation, follow STEP 2B

Step 2A Wood Stud Option

! WARNING:

Do not use a drill for tightening the lag screws! Only use a socket wrench.

Avoid potential personal injury or property damage! DO NOT over-tighten the lag screws! **DO NOT** use the anchor in drywall or wood studs.

DO NOT USE ANCHOR [A2] FOR THIS STEP.

Ensure the wall plate is securely fastened to the wall before continuing to the next step.



Do not use the anchor in wood studs or drywall. Use only in concrete walls.

2A-1

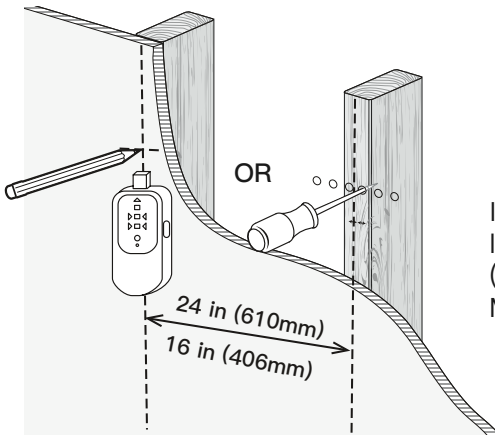

Pencil
(Not Included)



Awl
(Not Included)

Use a pencil to locate wood studs or use an awl (not included) to verify the edges. Mark the edge and center locations.

2A-2

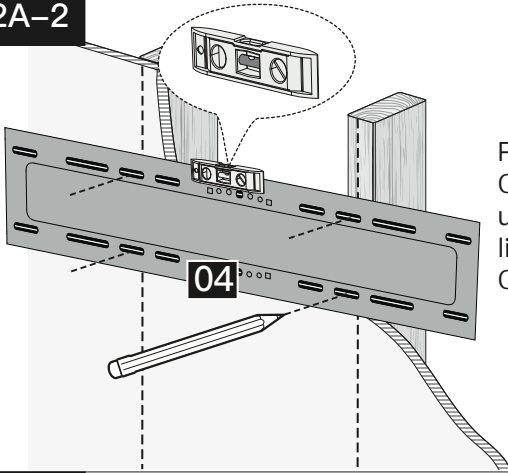

Position the wall plate template at your desired height and line up the holes with your stud center line. Level the wall plate template and mark the holes.

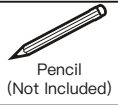
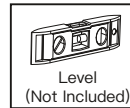

2A-3

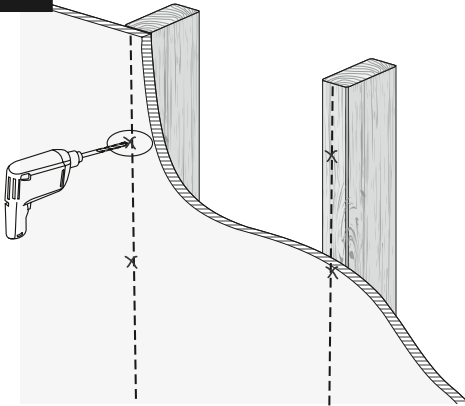

Drill pilot holes using a 7/32 in (5.5mm) diameter drill bit. Make sure the depth is not less than 2 3/4 in (70mm).

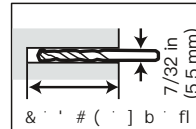

2A-4

Note: Do not use a drill to tighten the lag screws. Only use a socket wrench.

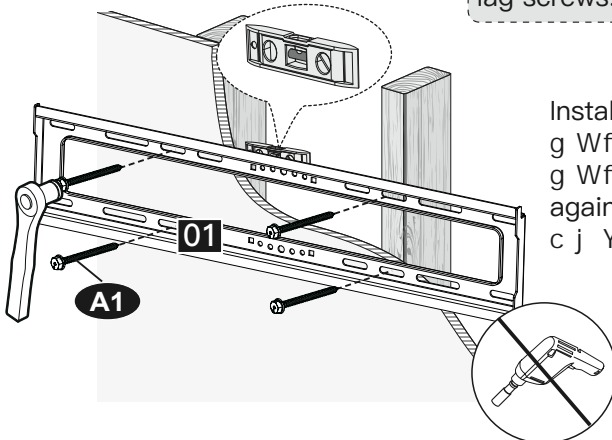

Install the wall plate using lag screws against the wall plate. DO NOT use a drill to tighten the lag screws. Only use a socket wrench.

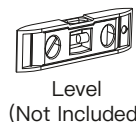

Step 2B Solid Concrete Wall Option

⚠ WARNING:

Do not use a drill for tightening the lag screws! Only use a socket wrench.

g Wf Y k g " 05 % Q " " H] [\ h Y b " h \ Y " " U [" gh Wfh \ k Y g " k Q 5 % Q " d] g U

9 b g i f Y " h \ Y " k U " " d " U h Y "] g " g Y W i W c b h h b U g h Y b Y X " ing to the next step.

" A c i b h " h \ Y " k U " " d " U h Y " X] f Y W h " i m h " b " h \ any covering.

" H \ Y " h \] W _ b Y g g " c Z " h \ Y " W c b W f Y h Y Ł K U " " a i g

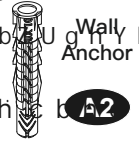

2B-1

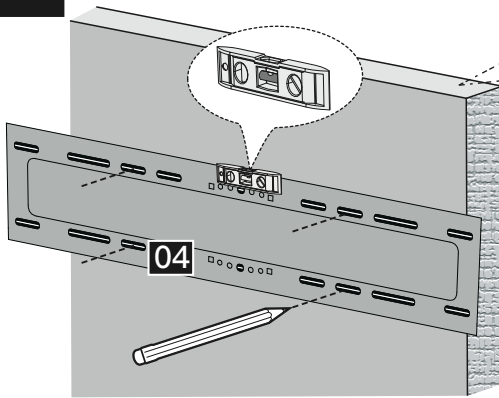

Wall Thickness:
7 E " O i
(140mm)

Position the wall plate
h Y a d " U hat you desired
height. Level the wall plate
h Y a d " U hand mark the pilot
hole locations.

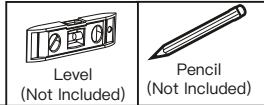

2B-2

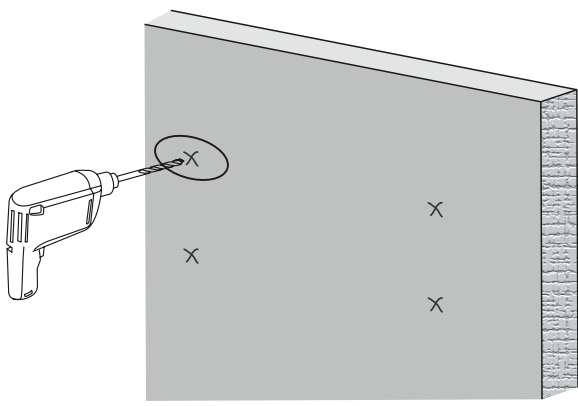

Drill 4 pilot holes using a
3/8 in (10mm) diameter drill
bit. Make sure the depth is
not less than 3 in (75mm).

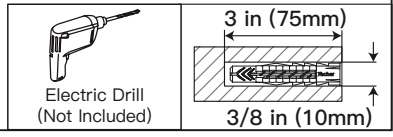

2B-3



Hammer
(Not Included)

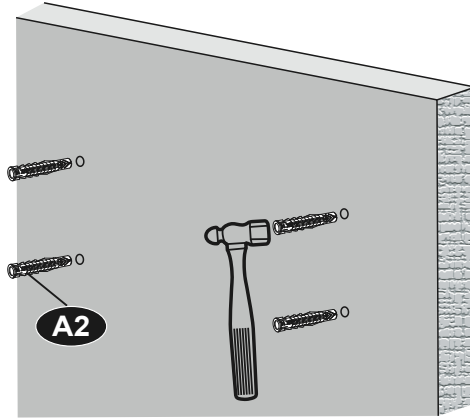

I g Y h \ Y \ U a a Y f h c _ b c W _ U b W \ c f g 05 & Q
U b W \ c f g 05 & Q U f Y g Y U h Y X i g \ k] h \ h \

2B-4

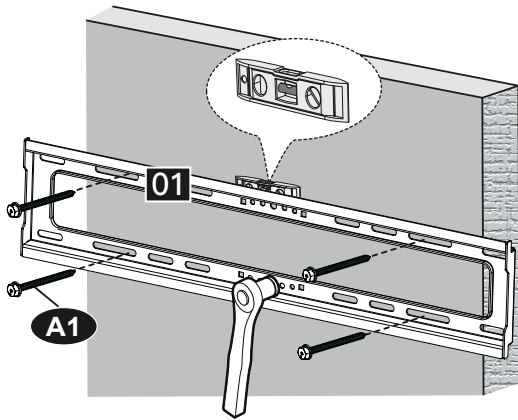

= b g h U h \ Y k U d U h Y O \$ % Q i g I b [U
g W f Y k g 05 % Q] g d i Y X f a m U [U] b g h
c j Y f ! h] [\ h Y b h \ Y U [g W f Y k g 05 % Q "

Note: Do not use a drill to tighten the lag screws. Only use a socket wrench.

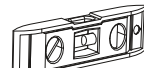

Level
(Not Included)



1/2 in (13mm)
Socket Wrench
(Not Included)

Step 3 Secure the TV onto the Wall Plate

To Hang TV onto the Wall Plate

1. Gently press the bottom of the TV towards the wall until you hear the safety locks “click” into place on both sides of the mount.

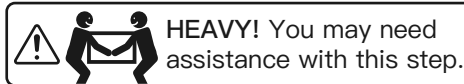
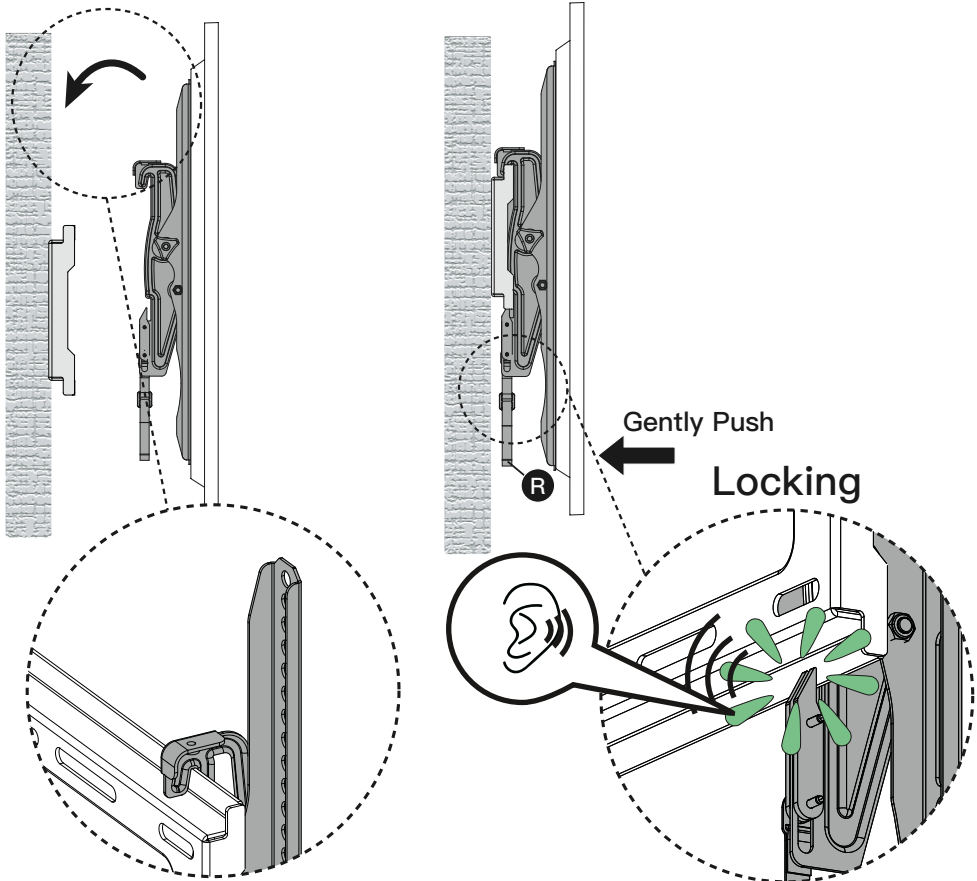

Caution: to avoid potential injury and person property damage, two people should assist in removing the TV from the mount.

1. Verify that all cables are disconnected from the back of the TV and the TV is unplugged from wall.
2. While gently applying pressure to the front of the TV towards the wall, pull down on the safety straps until they are full disengaged.
3. While keeping the straps in the disengaged position, move the bottom of the TV

Supplied Hardware for Step 4

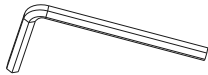

13/64 in (5mm)
Allen Key

x1

Step 4 Adjustment

Tilt Adjustment

1. Use tension knobs on the sides of the TV Brackets to allow adjustment of the TV to desired position.
2. After making any adjustments, always re-tighten the tension knobs to hold TV in place and avoid unwanted movement.

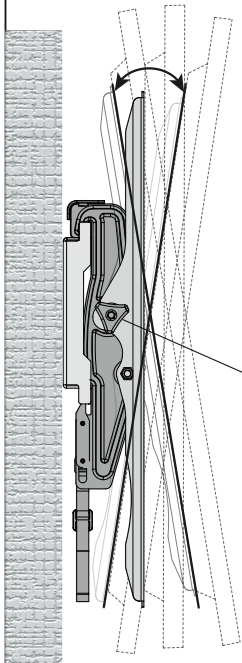

⚠ CAUTION!

Please do not over-tighten
or over-loosen the knobs.

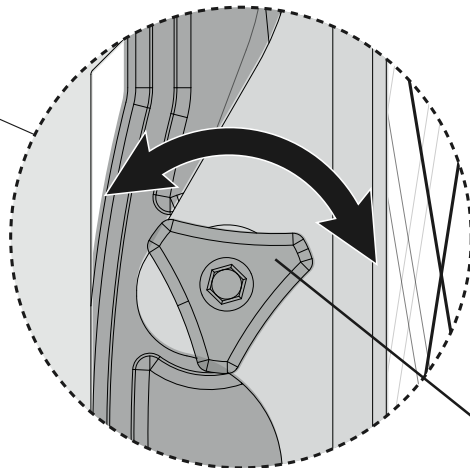

K



13/64 in (5mm)
Allen Key

Consignes de sécurité importantes

T Q b WU Veuillez lire attentivement toutes les instructions avant de tenter l'installation. Si les instructions ne vous semblent pas claires ou si vous avez des questions, veuillez contacter notre service d'assistance technique au (877) 419-7832 ou notre service clientèle à l'adresse support@ergoav.com.

ATTENTION: L'utilisation avec des produits plus lourds que les poids maximums indiqués peut entraîner une instabilité et des blessures possibles.

- Ne dépassez pas la capacité de charge. Nous ne sommes pas responsables des dommages ou blessures causés par un montage incorrect, un assemblage incorrect ou une utilisation inappropriée.
- Ce produit est conçu pour être utilisé dans les murs à ossature de bois et les murs en béton massif. – NE PAS installer dans une cloison sèche seule.
- Le mur doit être capable de supporter quatre fois le poids du téléviseur et du support combinés.
- Utilisez ce système de montage uniquement pour l'usage auquel il est destiné, tel que décrit dans ces instructions. N'utilisez pas d'accessoires non recommandés par le fabricant.
- Ne pas utiliser à l'extérieur.
- Achetez correctement les cordons et les câbles pour éviter tout dommage mécanique.
- SAUVEGARDER CES INSTRUCTIONS.

Restrictions de poids



Si votre téléviseur pèse plus lourd, n'utilisez pas ce produit.

⚠ AVERTISSEMENT

NE PAS dépasser le poids maximum indiqué. Ce support TV est destinée à être utilisé uniquement dans la limite des poids maximums indiqués. L'utilisation de produits plus lourds que les poids maximums indiqués peuvent entraîner une défaillance du support TV et de ses accessoires, et provoquer des dommages et/ou des blessures.

j Ó y " â y " é ñ x â y " j U g Q " x " h j " u

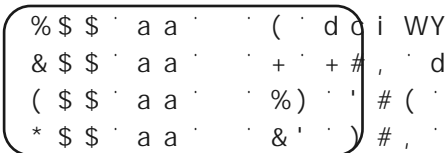
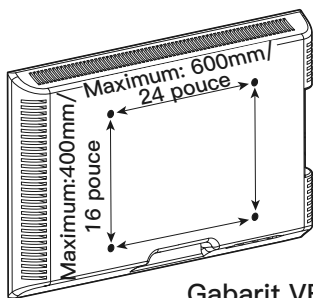

Gabarit VESA minimal: 200mmx100mm/8 pouce x 4 pouce

Si le gabarit VESA de votre téléviseur mesure plus de 600x400mm/24x16 pouce ou moins de 200x100mm/8x4 pouce, ce support de téléviseur N'EST PAS compatible.

Si ce support n'est PAS compatible, veuillez contacter notre ligne d'assistance technique au (877) 419-7832 ou notre service clientèle à l'adresse support@ergoav.com pour trouver un support compatible.

Outils nécessaires (non inclus)



Détecteur de goujons



Ailette



Mètre ruban



Crayon



Foreuse

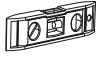

Niveau



7/32 pouce (5.5mm)
Foret à bois



1/2 pouce (13mm)
Clé à douille



Tournevis Phillips

(Nécessaire pour les installations en



3/8 pouce (10mm)
Foret à béton



Marteau-piqueur

j ó y " â u " w ñ í w Ó ñ í " x y " ñ "

ATTENTION
NE PAS installer dans une cloison sèche seule

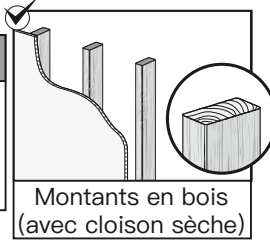

Montants en bois (avec cloison sèche)

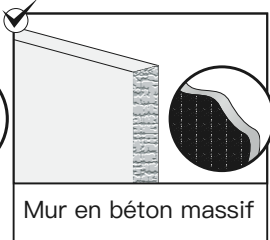

Mur en béton massif

Si vous n'êtes pas sûr de la construction du mur, veuillez contacter notre ligne d'assistance technique au (877) 419-7832 ou notre service clientèle à l'adresse support@ergoav.com.

d ó w y " y " é u Ó y â " i ñ í Ó

AVERTISSEMENT. N'utilisez pas de pièces endommagées ou défectueuses. Si vous avez besoin de pièces de rechange, veuillez contacter notre ligne d'assistance technique au (877) 419-7832 ou notre service clientèle à l'adresse support@ergoav.com.
• j y Ó â â y le matériel inclus dans cet ensemble ne sera pas utilisé en totalité.

d ó w y " y " é u Ó y â " i ñ í Ó " ó ñ

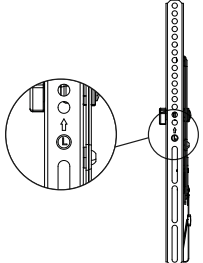

Support TV droit
02 x1

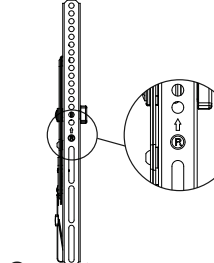

Soporte para TV derecho
03 x1

Entretoises
Remarque: Les entretoises sont présentées en taille réelle.

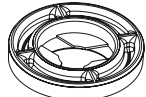

L2.5mm
F1 x8

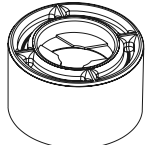

L10mm
F2 x4

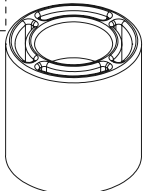

L22mm
F3 x4

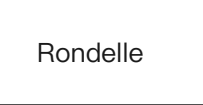

Rondelle
B1 x4



M6/M8
B2 x4

Boulons de téléviseur

Remarque: Les boulons sont représentés en taille réelle

M4

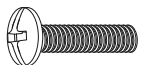

M4x12mm

C1 x4



M4x30mm

C2 x4

M6

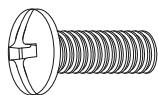

M6x15mm

D1 x4

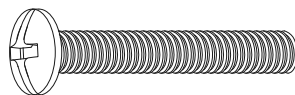

M6x35mm

D2 x4

M8

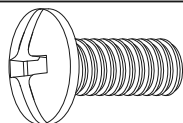

M8x15mm

E1 x4

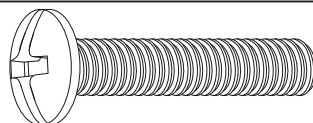

M8x35mm

E2 x4

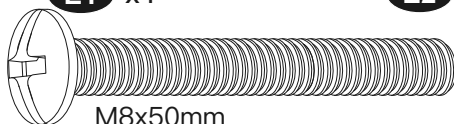

M8x50mm

E3 x4

Étape 1

g â y w Óñ í y ” â

Une seule taille de boulon convient à votre téléviseur.

M4 M6 M8

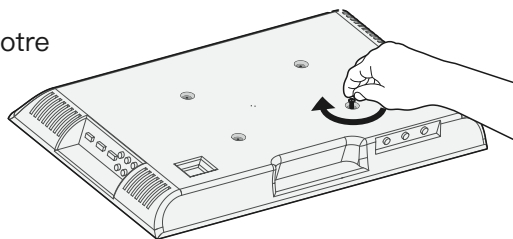

@ c b [i y i f X Y \ U V c i \ c b \ J Æ f] Y ñ Y b [U [Æ Y U]
 les boulons ou la combinaison boulons/entretroises. Nous recommandons un
 Y b [U [Y a Y b h X i Y h U [Y g i f U i \ a c] b g) h c i

- Trop court, le téléviseur ne sera pas maintenu.

- Trop long, le téléviseur sera endommagé.

Remarque : Ne serrez pas trop les boulons de téléviseur pour ne pas l'endommager.



Trop court

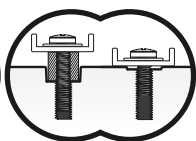

Correct



Trop long

Lors de l'utilisation des entretoises, il est important de noter qu'elles peuvent être utilisées sur plusieurs couches (c'est-à-dire empilées). Si vous rencontrez un problème lors de l'installation sur votre téléviseur, veuillez contacter notre service d'assistance technique au (877) 419-7832 ou notre service clientèle à l'adresse support@ergoav.com.

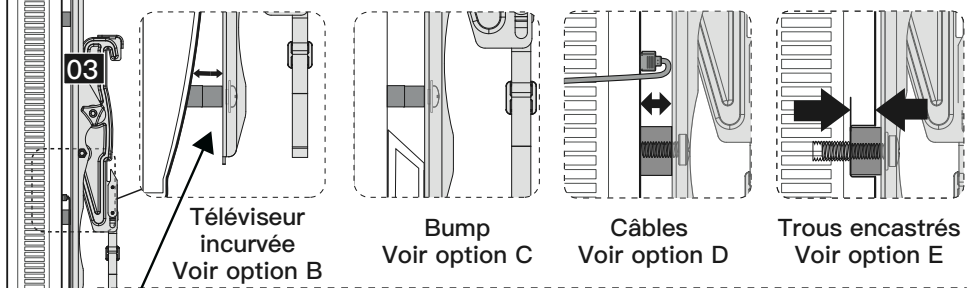
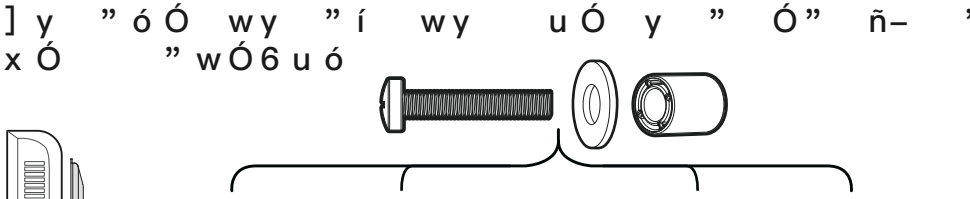

Entretoises

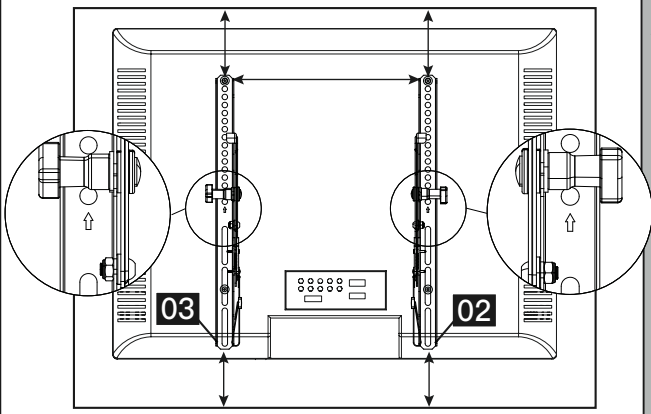
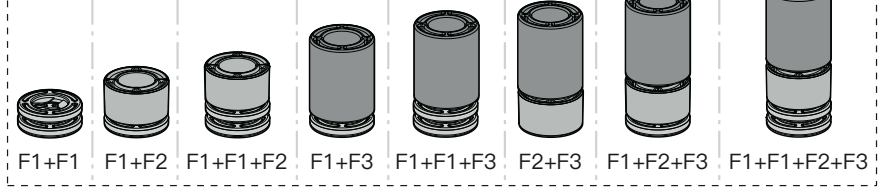

⚠ ATTENTION: Lorsque vous installez les entretoises sur votre téléviseur, assurez-vous que les trous des boulons sont alignés vers le haut du téléviseur et qu'elles sont également centrées sur l'arrière du téléviseur.

⚠ EUILLEZ NOTER: Les emplacements des trous de boulon sur votre téléviseur peuvent varier en fonction du design du fabricant du téléviseur. Nous représentons seulement les emplacements possibles des trous des boulon.

Option A (pour un téléviseur à dos plat)

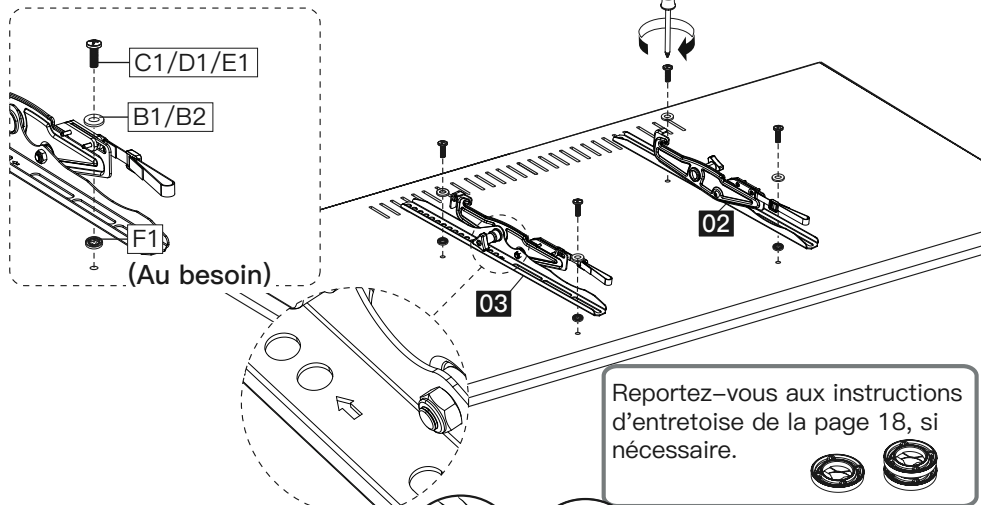

(Au besoin)

Reportez-vous aux instructions d'entretoise de la page 18, si nécessaire.



REMARQUE : @ U À W \ Y j Y f doit être dirigée vers le haut du téléviseur.

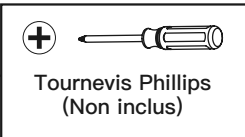

Option B (pour un téléviseur à dos arrondi)

@ U \ U i h Y i f \ X Y g \ Y b h f Y h c] g Y g \ X c] U h \ W c h i f f W \ Y g i 1/2 g U f i b l e téléviseur n'interfère avec la plaque de montage.

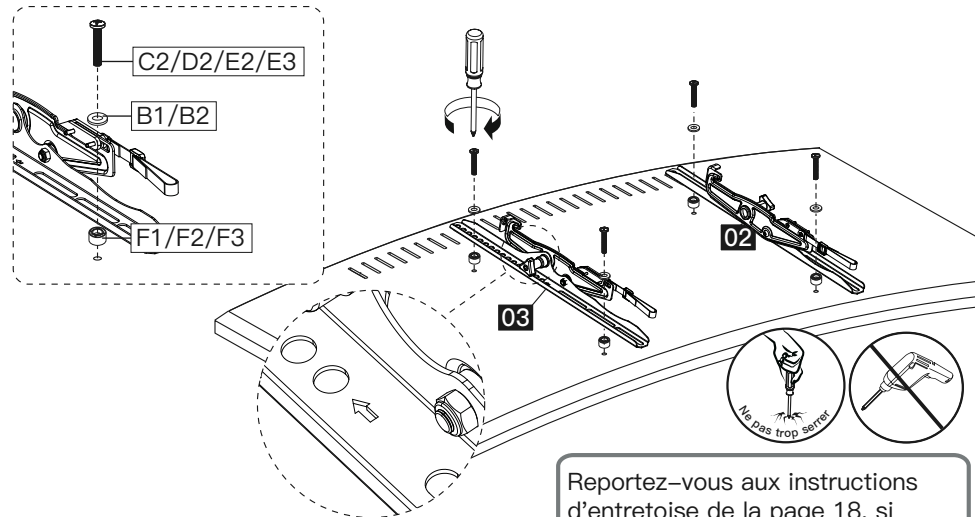

REMARQUE : @ U À W \ Y j Y f g \ Y \ U doit être dirigée vers le haut du téléviseur.

Reportez-vous aux instructions d'entretoise de la page 18, si nécessaire.



Option C (pour un téléviseur avec une surépaisseur)

@Y g` Y b h f Y h c] g Y g` X c] j Y b h` Ç h f Y`
 que les supports de télévision soient alignés (PAS D'ÉCART) sur la bosse.

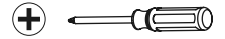

Tournevis Phillips
 (Non inclus)

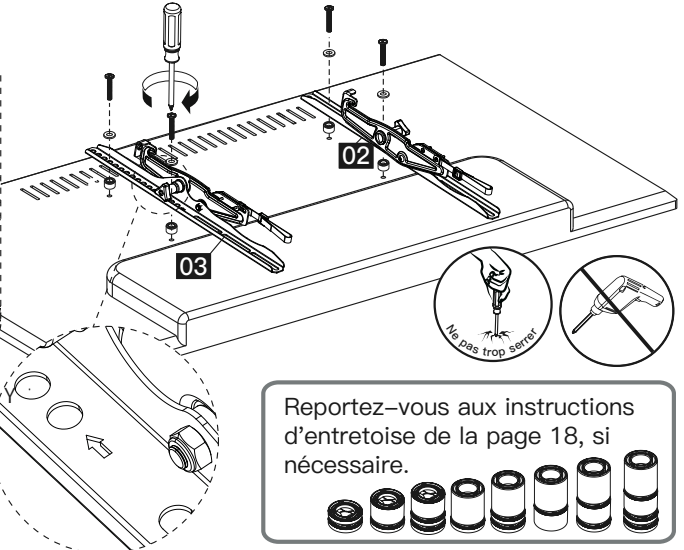
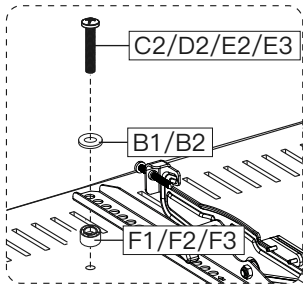

REMARQUE : @ U` À W V`
 vers le haut doit être dirigée vers le haut du téléviseur.

Reportez-vous aux instructions d'entretoise de la page 18, si nécessaire.

Option D (pour téléviseur avec interférence du câble)

Pour éviter les interférences entre les câbles, utilisez les Y b h f Y h c] g Y g` O : % Q ž` O : & Q` Y h` O : Q` d c i f` W f A E`
 supplémentaire entre le téléviseur et les supports TV.



Tournevis Phillips
 (Non inclus)

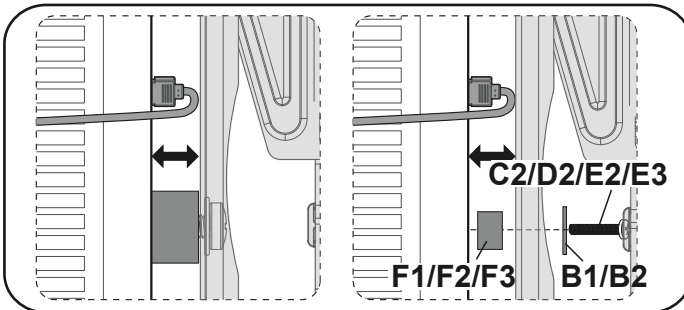

Reportez-vous aux instructions d'entretoise de la page 18, si nécessaire.

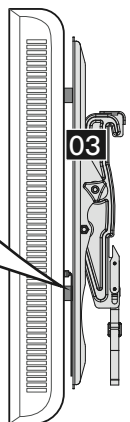
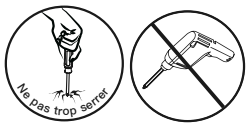

Option E (Pour les trous encastrés)

L'entretoise doit remplir les trous en retrait sur la base
 Xi h Æ Æj] g Y i f U b e i Y Y g g i d d C T H g H J

proches que possible du téléviseur.



Tournevis Phillips
 (Non inclus)

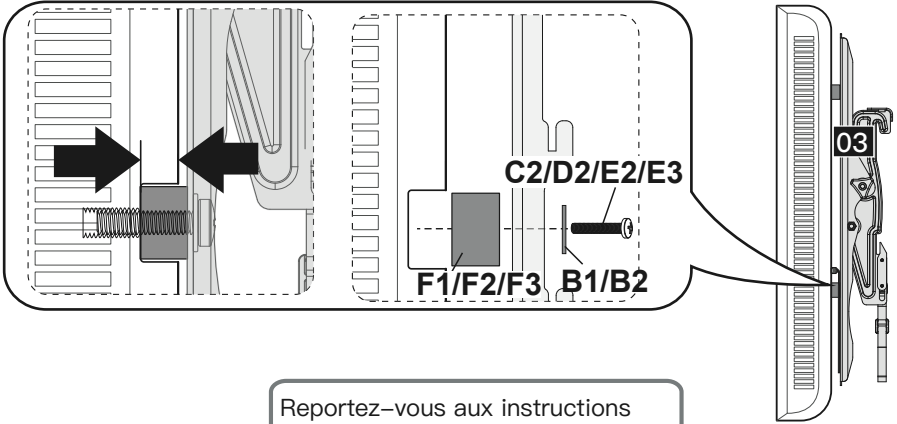

Reportez-vous aux instructions
 d'entretoise de la page 18, si
 nécessaire.



d Ó w y " y " é u Ó y â " i ñ í Ó " ó ñ

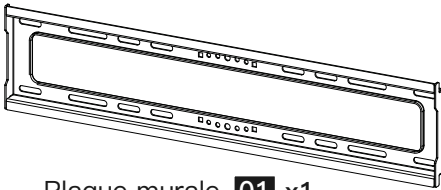

Plaque murale **01** x1



Modèle de mur **04** x1

Remarque : Le tire-fond est représenté en taille réelle

A1 x4

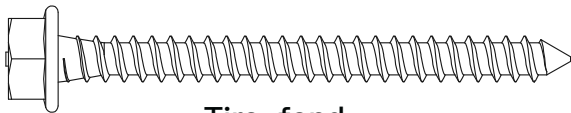

Tire-fond
 5/16X2 3/4 pouce

A2 x4 Ancre de mur 10X60mm

! ATTENTION!
 Cet ancrage est destiné aux murs en béton UNIQUEMENT. NE PAS les utiliser sur les montants en bois.



Étape 2 Fixer la plaque murale [01] au mur

d ñ " â 0 Ó í u â â u Ó ñ í " x y " é ñ í u í " y í " v ñ Ó 5
 d ñ " â 0 Ó í u â â u Ó ñ í " x y " v ñ í 5 " Ó y " â 0

Étape 2A Option montants en bois

! AVERTISSEMENT:

N'utilisez pas de perceuse pour serrer les tire-fonds ! Utilisez uniquement une clé à douille.

Évitez les blessures corporelles ou les dommages matériels potentiels ! NE fermez pas fermement contre la plaque murale.

b U " d Q g " i h Y] Y g U f "] 0 Q b S f Q W U " o Q B q " X Ancre de mur A2
 5 g g i f Y n ! j c i g e i Y " U " d " U e i Y " a i f U " Y mur A2
 avant de passer à l'étape suivante.



H U] " Y " b c a] b U " Y " X Y g " a c b h U b h g " Y b " % \$ &] g . a t W o
 @ Y " W Y b h f Y " X Y g " a c b h U b h g " X c] h " Ç h f Y " j Æ f] Æ "

2A-1

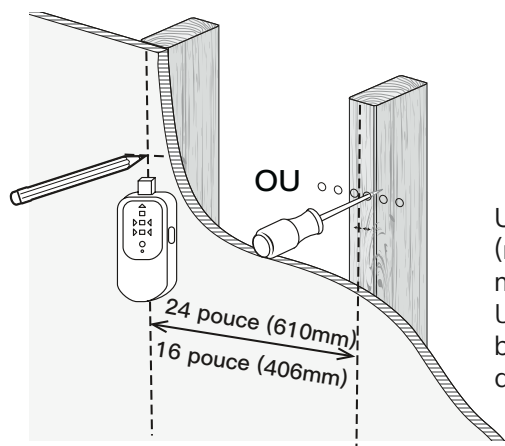
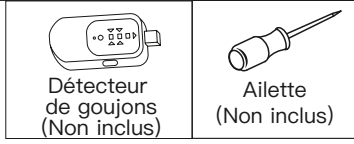

Utilisez un détecteur de montants (non inclus) pour localiser les montants en bois ou utilisez une ailette (non inclus) aux bords. Marquez les emplacements du bord et du centre.

2A-2

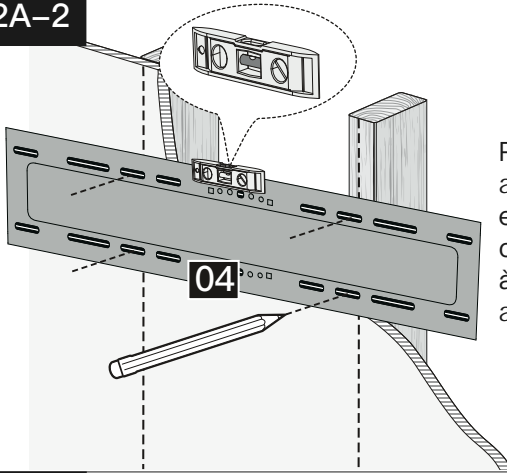

Positionnez le modèle de plaque à l'aide d'un niveau et alignez les trous avec la ligne centrale de votre montant. Mettez à niveau le modèle de plaque à l'aide d'un crayon.

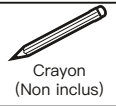

2A-3

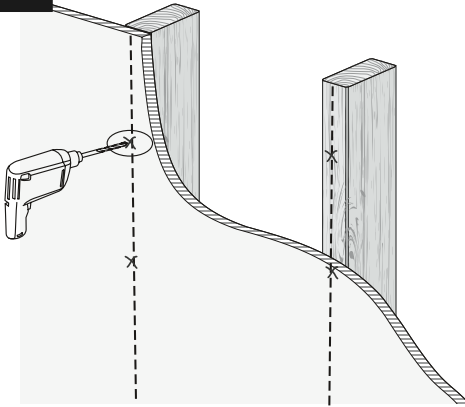

Percez des trous pilotes à l'aide d'un foret de 7/32 pouce (5,5 mm) de diamètre. Assurez-vous que la profondeur n'est pas inférieure à 2 3/4 pouce (70 mm).

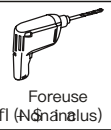
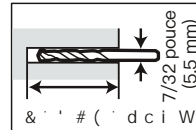

2A-4

Remarque : N'utilisez pas de perceuse pour serrer les tire-fonds. Utilisez uniquement une clé à douille.

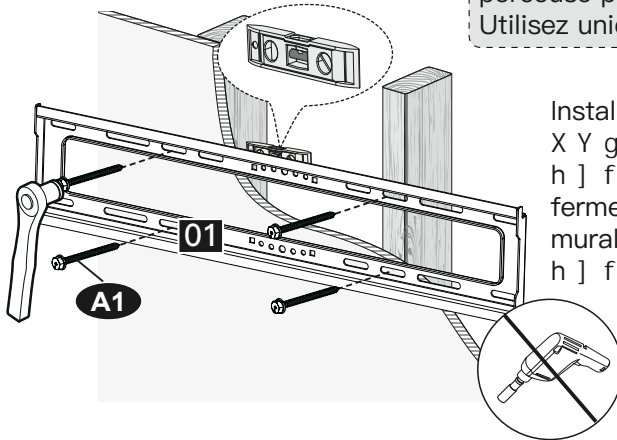

Installez la plaque murale à l'aide d'une clé à douille. NE SERREZ PAS trop les tire-fonds.

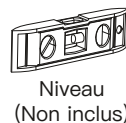

Étape 2B Option de mur en béton massif

! AVERTISSEMENT:

N'utilisez pas de perceuse pour serrer les tire-fonds ! Utilisez uniquement une clé à douille.

la plaque murale.

passer à l'étape suivante.

aucun revêtement.



2B-1

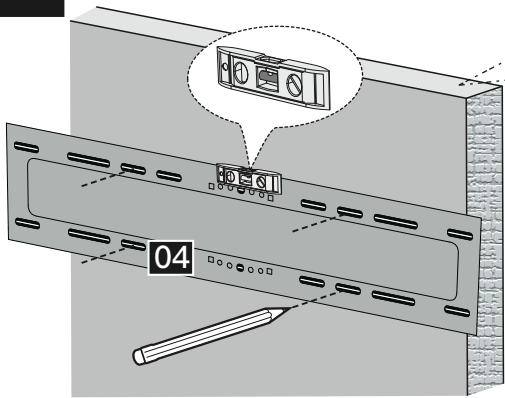

5,5 pouce (140mm)

Positionnez le modèle de plaque à l'endroit souhaité. Mettez à niveau le modèle. Marquez les emplacements des avant-trous.

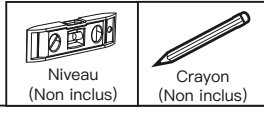

2B-2

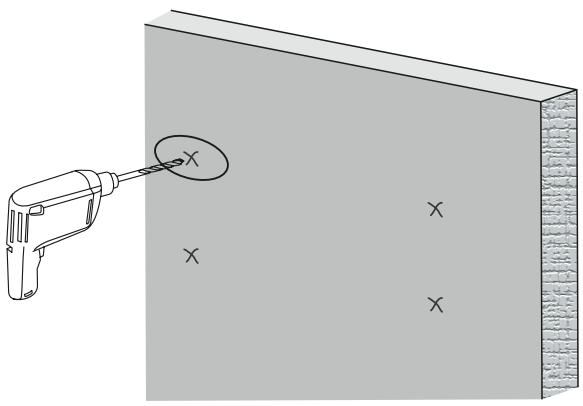

Percez 4 trous pilotes à l'aide d'un foret de 3/8 pouce (10 mm) de diamètre. Assurez-vous que la profondeur n'est pas inférieure à 3 pouce (75 mm).

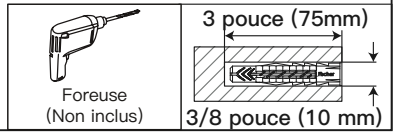

2B-3

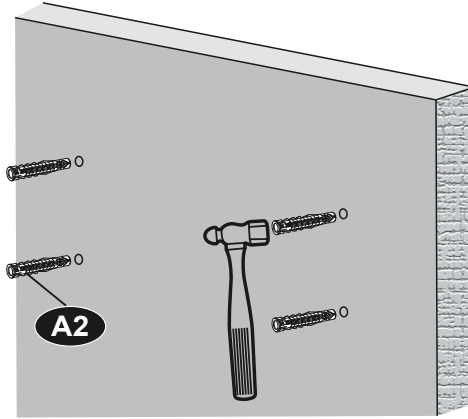

l h] ^] g Y n ^ ^ Y ^ a U f h Y U i ^ d c i f ^ Y b Z c b " W Y f ^ ^ Y
 J Y] ^ ^ Y n ^ 1/2 ^ W Y ^ e i Y ^ ^ Y g ^ U b W f U [Y g f 0 5 & W Y ^ g
 du béton.

2B-4

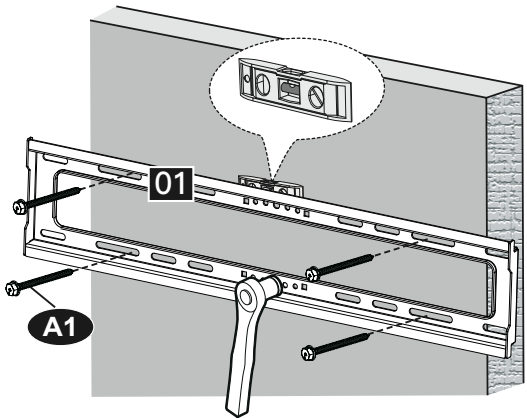

= b g h U ^ ^ Y n ^ ^ U ^ d ^ U e i Y ^ a i f U ^ Y ^ O \$ % Q ^ 1/2 ^ fi
 G Y f f Y n ^ ^ Y g ^ h] f Y ! Z c b X g ^ O 5 % Q ^ Y h ^ h] f Y n !
 d ^ U e i Y ^ a i f U ^ Y ^ O \$ % Q " ^ B 9 ^ G 9 F F 9 N ^ D 5 G ^ h f

Remarque : N'utilisez pas de perceuse pour serrer les tire-fonds. Utilisez uniquement une clé à douille.

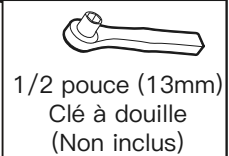
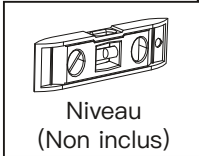

Étape 3 Fixer le téléviseur sur la plaque murale

Pour accrocher le téléviseur sur la plaque murale

2. Appuyez doucement sur le bas du téléviseur vers le mur jusqu'à ce que vous entendiez les verrous de sécurité se mettre en place des deux côtés du support.

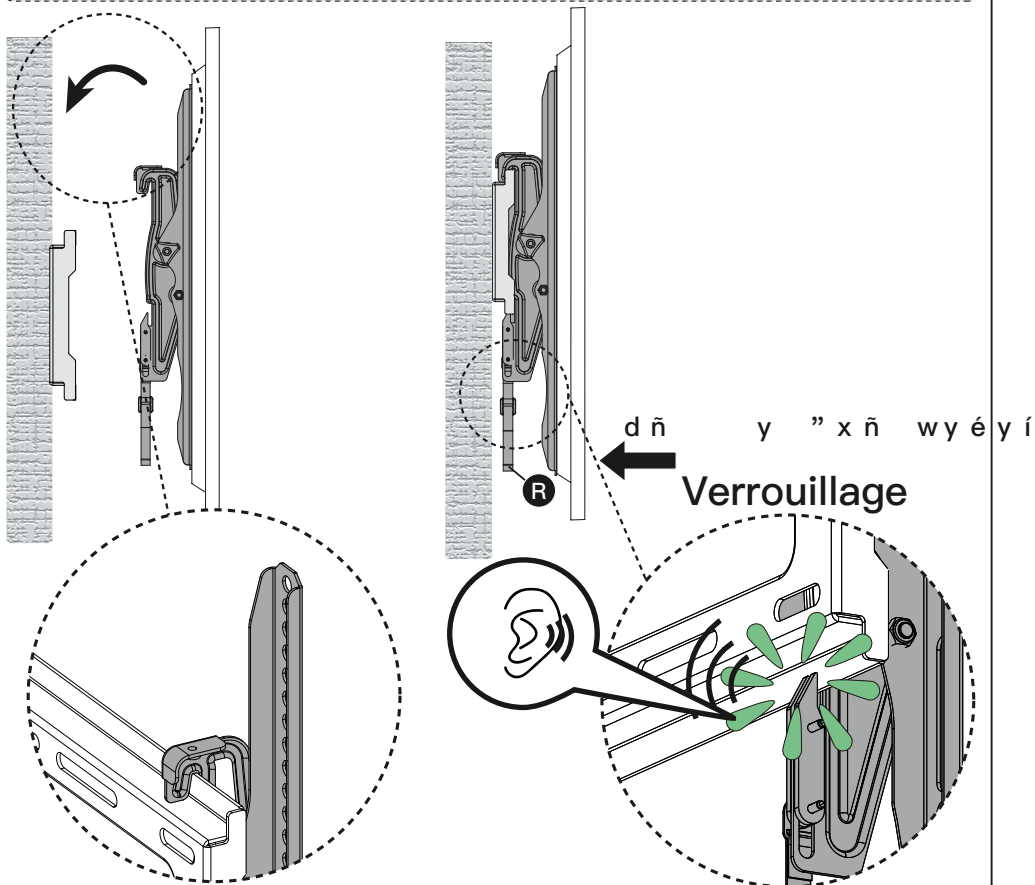

LOURD! vous aurez peut-être besoin d'aide pour cette étape.

Attention : pour éviter toute blessure potentielle et tout dommage matériel, deux personnes doivent aider à retirer le téléviseur du support.

téléviseur est débranché du mur.

2. Tout en exerçant une légère pression sur l'avant du téléviseur vers le mur, tirez sur les sangles de sécurité jusqu'à ce qu'elles soient complètement désengagées.

3. Tout en maintenant les sangles en position désengagée, éloignez le bas du téléviseur du mur et soulevez le téléviseur de la plaque murale.

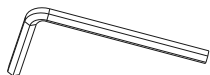

13/64 pouce (5mm) x1
Clé hexagonale

Étape 4 Réglage

f Á â u Á y ” x y ” â

1. Utilisez les boutons de tension sur les côtés des Support TV pour permettre le réglage du téléviseur dans la position souhaitée.
2. Après tout réglage, resserrez toujours les boutons de tension pour maintenir le téléviseur en place et éviter tout mouvement indésirable.

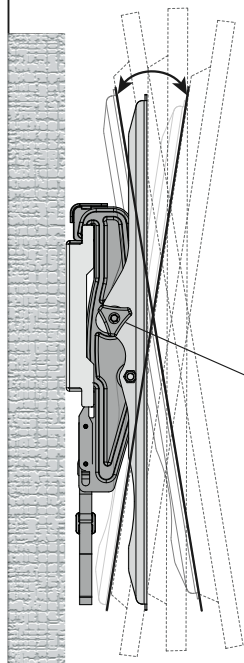

⚠ ATTENTION!

Veuillez ne pas trop serrer ou trop desserrer les boutons.

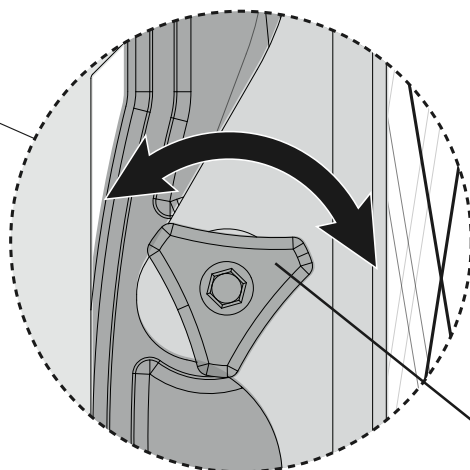

K



13/64 pouce (5mm)
Clé hexagonale

INFORMACIÓN IMPORTANTE DE SEGURIDAD

¡PELIGRO! Por favor, lea cuidadosamente todas las instrucciones antes de realizar la instalación. Si no entiende las instrucciones o tiene alguna duda o consulta, póngase en contacto con nuestra línea de asistencia técnica llamando al (877) 419-7832, o escribiendo al servicio de atención al cliente en support@ergoav.com.

PRECAUCIÓN: El uso con productos más pesados que los pesos máximos indicados puede causar inestabilidad causando posibles lesiones.

Este producto está diseñado para su uso en montantes de madera y en paredes de hormigón sólido. – NO instalar solo en placa de yeso.

- Este producto está diseñado para su uso en montantes de madera y en paredes de hormigón sólido. – NO instalar solo en placa de yeso.
- La pared debe ser capaz de soportar cuatro veces el peso del televisor y del soporte juntos.
- Utilice este sistema de montaje sólo para el uso previsto, tal como se describe en estas instrucciones. No utilice accesorios no recomendados por el fabricante.
- No lo utilice en el exterior.
- Coloque los cables de forma apropiada para evitar daños mecánicos.
- **GUARDE ESTAS INSTRUCCIONES.**

Límites de peso

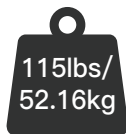

Si su televisor excede el peso, no utilice este producto.

⚠ ADVERTENCIA

NO exceda el peso máximo indicado. Este módulo para televisor solo debe usarse dentro de los pesos máximos indicados. Si se usa con productos que exceden los pesos máximos indicados es posible que se produzca una falla en el módulo para televisor y sus accesorios, posiblemente provocando daños y/o lesiones.

Revise el patrón VESA de la TV antes de la instalación

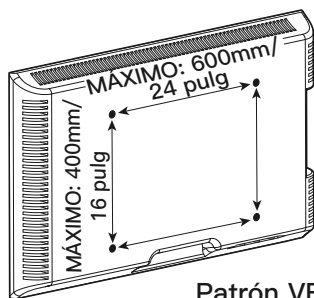

Patrón VESA mínimo: 200mmx100mm/8 pulg x 4 pulg

Si su televisor VESA mide más de 600x400 mm/24x16 pulg o menos que VESA 200x100mm/8x4 pulg, este soporte de televisor NO es compatible.

Si este soporte NO es compatible, póngase en contacto con nuestra línea de asistencia técnica al (877) 419-7832 o con el servicio de atención al cliente en support@ergoav.com.

Herramientas necesarias (no incluidas)

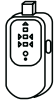

Detector de vigas



Punzón



Cinta métrica



Lápiz



Taladro

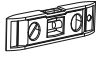

Nivel



7/32 pulg (5.5mm)
Broca para madera



1/2 pulg (13mm)
Llave de tubo



Destornillador
Philips

(Necesaria para las instalaciones
y í " É ñ é Ó A í



3/8 pulg (10mm)
Broca para
hormigón



Martillo

Inspeccione la construcción de su pared

PRECAUCIÓN

NO instalar solo en placa de yeso

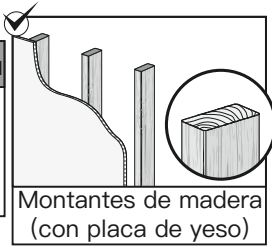

Montantes de madera
(con placa de yeso)



Pared de
hormigón sólido

Si no está seguro sobre las condiciones de construcción de su pared, póngase en contacto con nuestra línea de asistencia técnica en el (877) 419-7832 o con el servicio de atención al cliente en support@ergoav.com.

d Ó y u " " É y u é Ó y í u " ó ñ Ó u

ADVERTENCIA: Este producto contiene piezas pequeñas que pueden representar un riesgo de atragantamiento si se ingieren.

Antes de iniciar el montaje, compruebe que todas las piezas estén incluidas e intactas. No utilice piezas dañadas o defectuosas. Si necesita piezas de repuesto, póngase en contacto con nuestra línea de asistencia técnica al (877) 419-7832 o con el servicio de atención al cliente en support@ergoav.com

• Tenga en cuenta lo siguiente: Es posible que no necesite usar todos los herrajes incluidos en este envase.

d Ó y u " " É y u à y " é Ó í Ó u x ñ

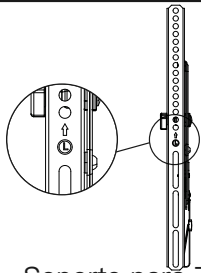

Soporte para TV
derecho

02 x1

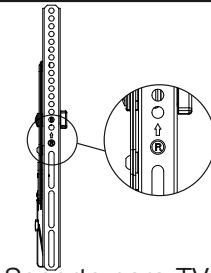

Soporte para TV
izquierdo

03 x1

Espaciadores

Nota: Los espaciadores se muestran en tamaño real.

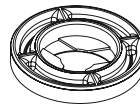

L2.5mm
F1 x8

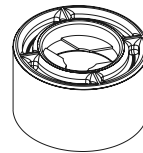

L10mm
F2 x4

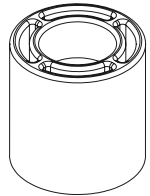

L22mm
F3 x4

Arandela

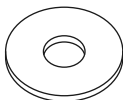

M4/M5
B1 x4

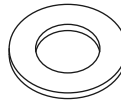

M6/M8
B2 x4

Pernos del televisor

Nota: Los pernos se muestran en tamaño real

M4

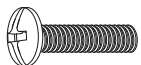

M4x12mm

C1 x4

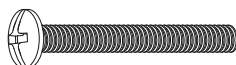

M4x30mm

C2 x4

M6

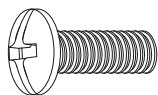

M6x15mm

D1 x4

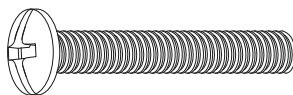

M6x35mm

D2 x4

M8

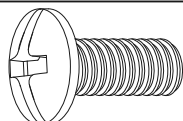

M8x15mm

E1 x4

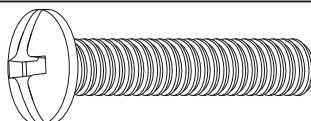

M8x35mm

E2 x4

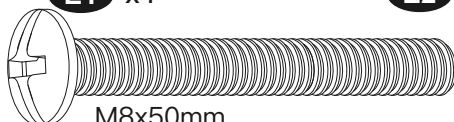

M8x50mm

E3 x4

Paso 1 Asegure los soportes de la TV a la TV

Seleccione el perno para el TV

Su televisor solo admite uno de los tamaños de perno.

M4 M6 M8

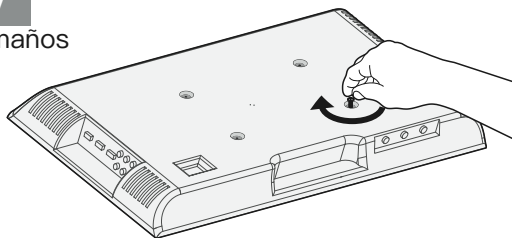
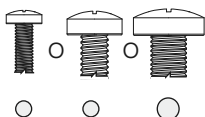

Longitud del perno: Compruebe que la rosca encaje correctamente con los pernos o la las combinaciones de pernos/espaciador. Se recomienda enganchar las roscas con 5 vueltas como mínimo.

- Si es demasiado corto, no soportará el TV.
- Si es demasiado largo, hará daños al TV.

Nota: No ajuste los pernos del televisor en exceso para no dañarlo.

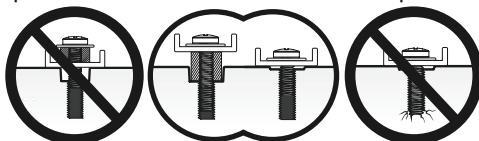

Demasiado corto

Correcto

Demasiado largo

Nota: Al utilizar espaciadores, es importante tener en cuenta que se pueden utilizar U d ` U X c g " ` G] ` h] Y b Y ` U ` [i b U ` X] W i j ` b t g t h X ` t U V f t b W X & a

pernos o espaciadores del televisor, póngase en contacto con nuestra línea de asistencia técnica al (877) 419-7832 o con el servicio de atención al cliente en support@ergoav.com.

d Ó y u " í y w y u Ó u " Ó " Ó y í y " í " y â
a continuación

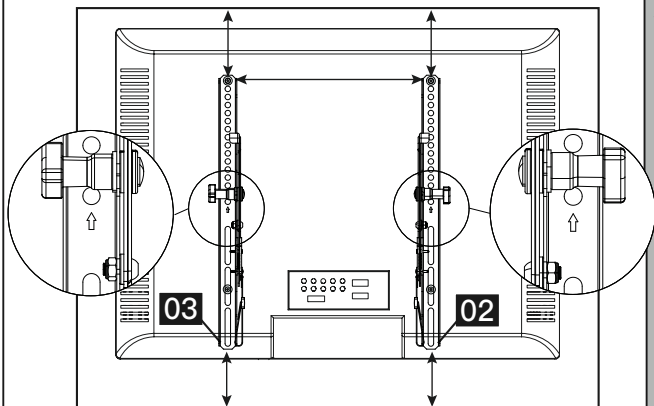
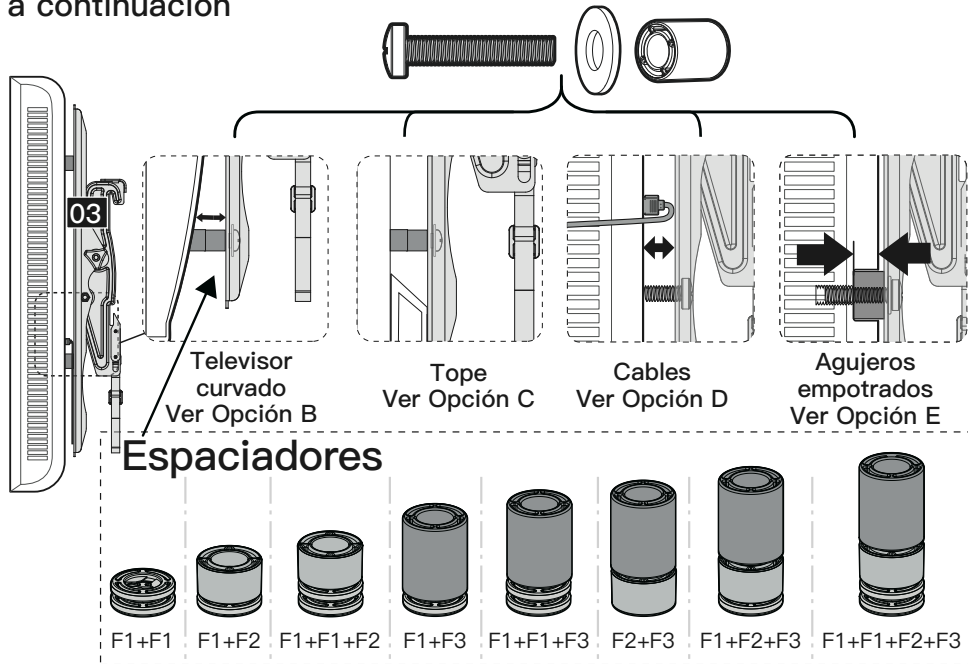

⚠ PRECAUCIÓN: Cuando
^ Y ` c g ` g c d c f h Y g d U f
parte posterior del televisor,
U g Y [x f Y g Y ` X Y ` e i Y ` U g
hacia arriba apunten a la parte
superior del televisor y estén
igualmente centradas en la
parte posterior del mismo.

⚠ NOTA: Las ubicaciones de
los agujeros para perno de su
televisor pueden variar según el
diseño del televisor de los
fabricantes. Solo ilustramos
algunas ubicaciones posibles de
dichos agujeros de los pernos.

Opción A (Para televisores con la parte trasera plana)

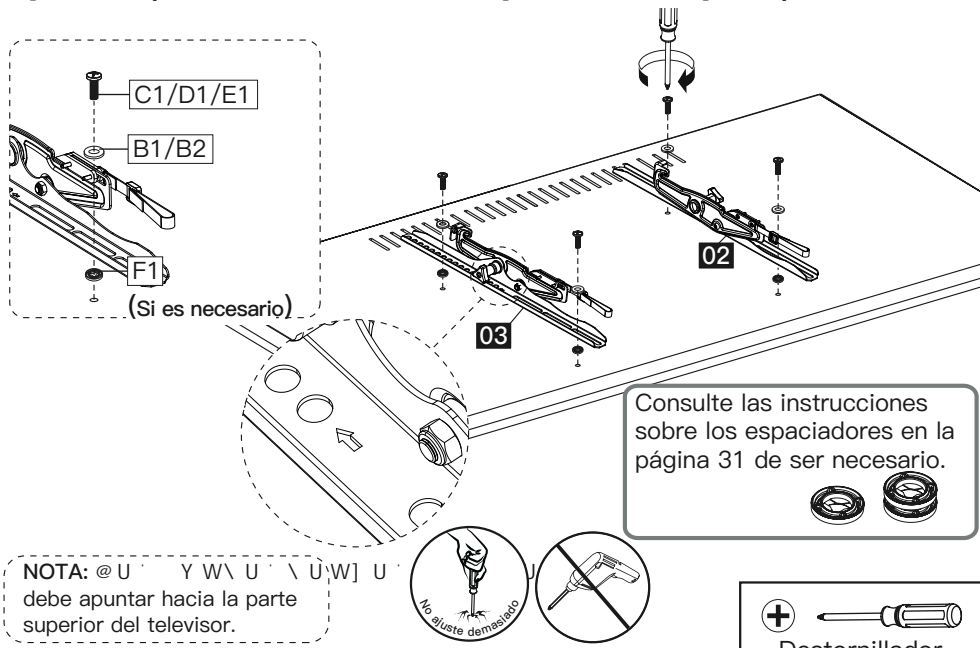

NOTA: @U` YW\U` \UW] U` debe apuntar hacia la parte superior del televisor.



⊕ Destornillador Philips (No se incluye)

Opción B (Para televisores con la parte trasera redondeada)

@cg` YgdUW] UXcfYg` XYVYb` gYf` `c` gWi fV]UY` bxhYY` a`YUb`hd` d`cg`hYf]cf` XY` `hY` Yj] gcf` bc`] bhYf` YfU` Wcb` `U`

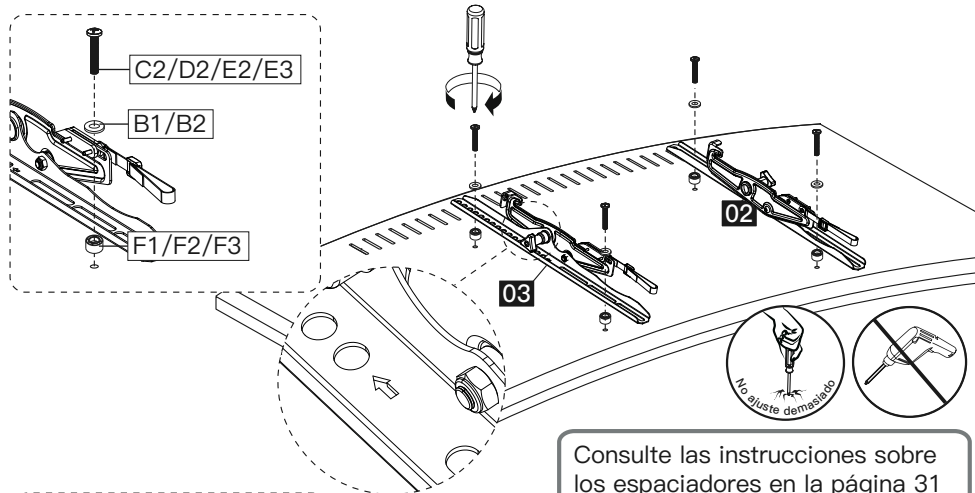

NOTA: @U` YW\U` \UW] U` Uff] VU` debe apuntar hacia la parte superior del televisor.



Consulte las instrucciones sobre los espaciadores en la página 31 de ser necesario.

Opción C (Para televisores con parte trasera saliente)

como para que los Soportes para TV queden al ras (SIN ESPACIO) del respaldo grande.



Destornillador
Philips
(No se incluye)

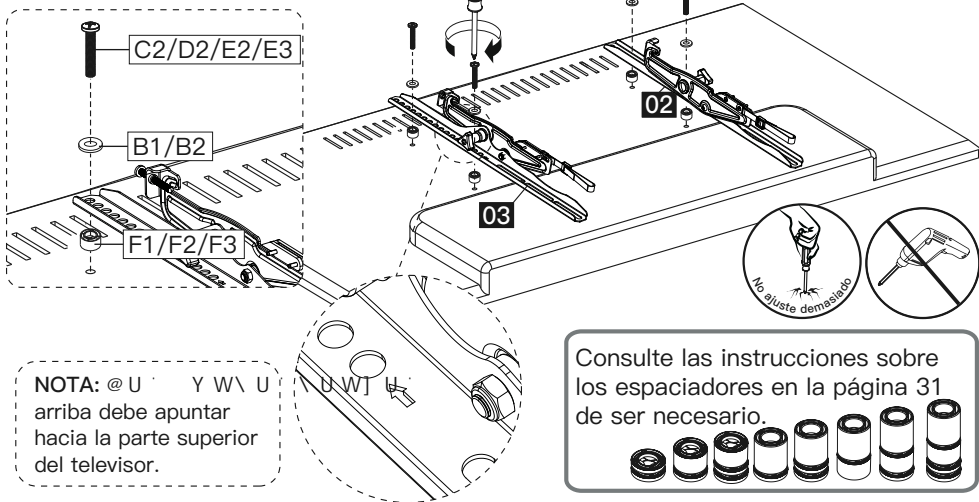

NOTA: @U Y W\ U arriba debe apuntar hacia la parte superior del televisor.

Consulte las instrucciones sobre los espaciadores en la página 31 de ser necesario.



Opción D (para televisor con interferencia de cables)

Para la interferencia de cables, utilice los espaciadores



Destornillador
Philips
(No se incluye)

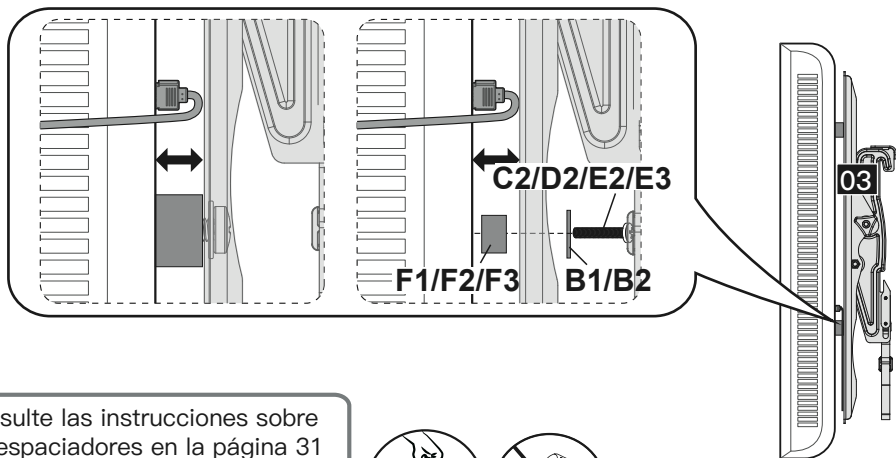

Consulte las instrucciones sobre los espaciadores en la página 31 de ser necesario.



Opción E (Para agujeros empotrados)

El espaciador debe rellenar los agujeros empotrados en la base del televisor para que los soportes para TV estén lo más cerca posible del mismo.

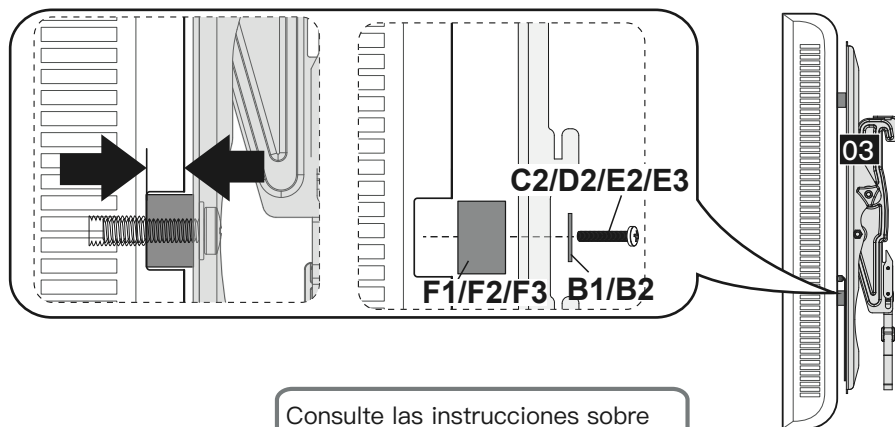
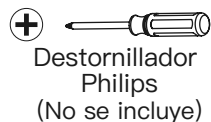

Consulte las instrucciones sobre los espaciadores en la página 31 de ser necesario.



d Ó y u ” ” É y u à y ” é Ó í Ó u x ñ

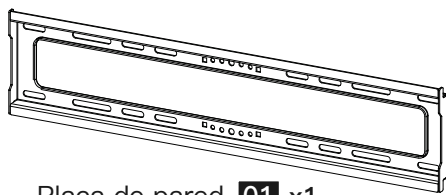

Placa de pared **01** x1

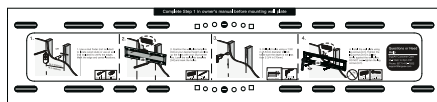

Plantilla de pared **04** x1

Nota: El tornillo de retraso se muestra en tamaño real

A1 x4

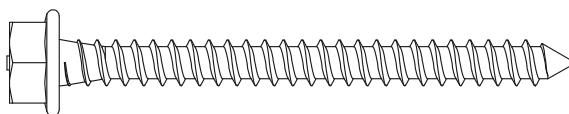

Tornillo de retraso
5/16X2 3/4 pulg

A2

x4

Anclas de pared
10X60mm

! PRECAUCIÓN!
Este taco es SOLO para paredes de hormigón. No los utilice en paredes de yeso o madera.

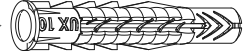

Paso 2 Fije la placa de pared [01] a la pared

Para la instalación en montantes de madera, siga el PASO 2A.

Para la instalación de hormigón, siga el PASO 2B.

Paso 2A Opción para montantes de madera

! ADVERTENCIA:

No utilice un taladro para ajustar los tornillos de retraso. Utilice únicamente una llave de tubo.

¡Evite posibles lesiones o daños a objetos de su propiedad! No ajuste demasiado la placa de pared.

NO UTILICE EL TACO [A2] PARA ESTE PASO.

Asegúrese de que la placa de pared esté bien sujeta a la pared antes de continuar con el siguiente paso.



Anclas de pared
A2

2A-1

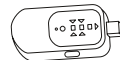
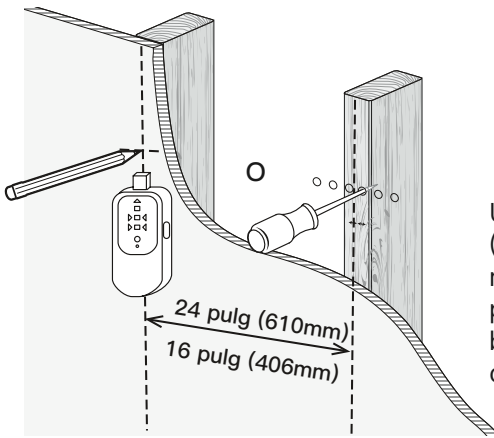

Detector de vigas
(No se incluye)



Punzón
(No se incluye)

Utilice un localizador de montantes (no incluido) para localizar los montantes de madera o utilice un punzón (no incluido) para revisar los bordes. Marque los bordes y el centro.

2A-2

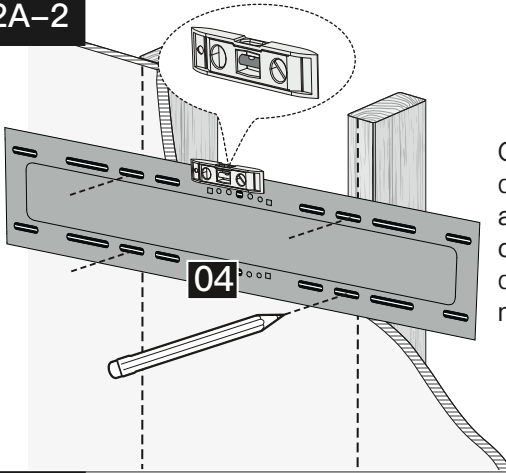

Coloque la plantilla de placa de
 d U f Y X O \$ (Q U U U h i
 alinee los agujeros con la línea
 central de los montantes. Nivele la
 d U b h] U X Y d U W U X
 marque los agujeros.



2A-3

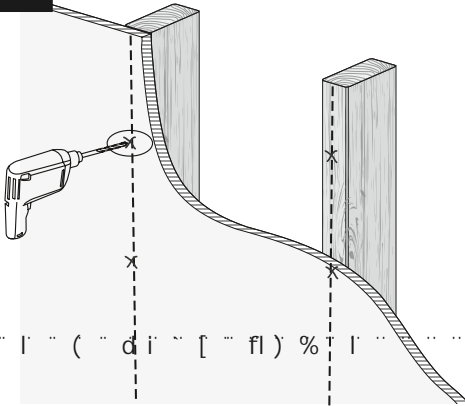

Taladre los agujeros provisionales
 con una broca de 7/32 in (5,5 mm)
 de diámetro. Asegúrese de que la
 profundidad no sea inferior a 2 3/4
 in (70 mm).

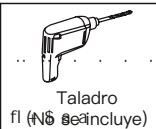
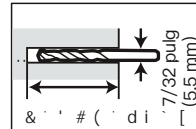

2A-4

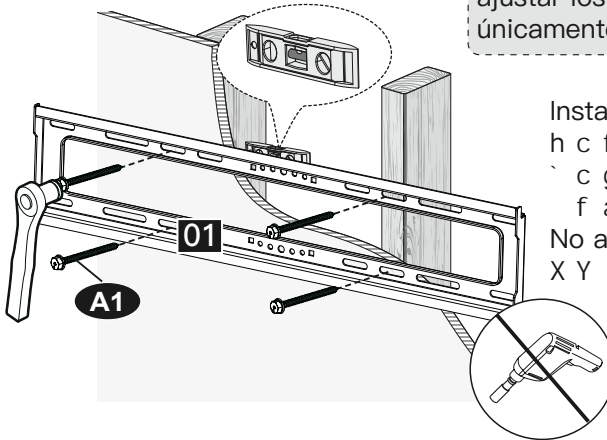

Nota: No utilice un taladro para
 ajustar los tornillos de retraso. Utilice
 únicamente una llave de tubo.

Instale la placa de pared con
 h c f b] c g X Y f Y h f U g
 c g h c f b] c g X Y f Y
 f a Y n U W c b h f U U d
 No ajuste demasiado los tornillos
 X Y f Y h f U g c O 5 % Q

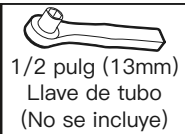
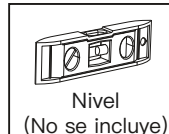

Paso 2B Opción de pared de hormigón sólido

⚠ ADVERTENCIA:

No utilice un taladro para ajustar los tornillos de retraso. Utilice únicamente una llave de tubo.

placa de pared.

de continuar con el siguiente paso.

sin ningún tipo de recubrimiento.



A2

2B-1

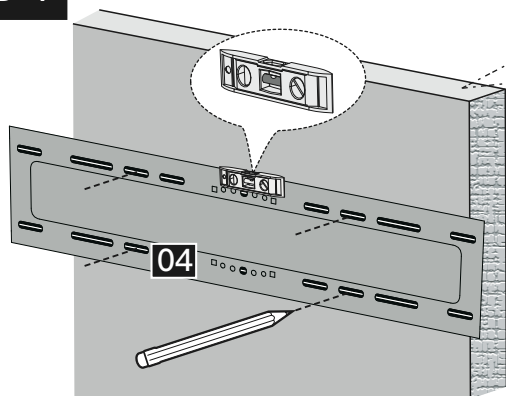

Grosor de la
"Óu y x" E5E "Óí"
(140 mm)

Coloque la Plantilla de Placa de DUFYX OS (Q U U U Nivele la Plantilla de Placa de DUFYX OS (Q m a U f e i ciones de los agujeros proviso- rios.

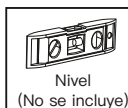

2B-2

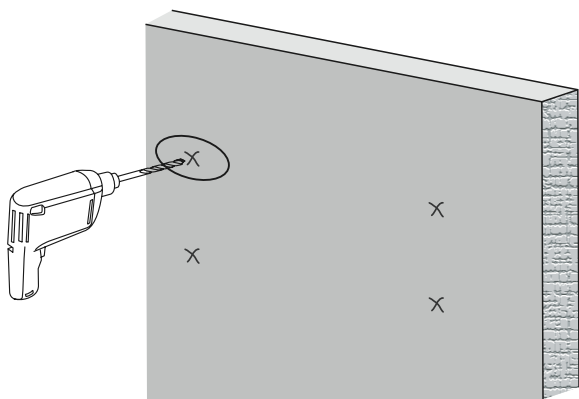

Taladre 4 agujeros piloto con una broca de 3/8 pulg (10 mm) de diámetro. Asegúrese de que la profundidad no sea inferior a 3 pulg (75mm).

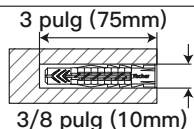

2B-3



Martillo
(No se incluye)

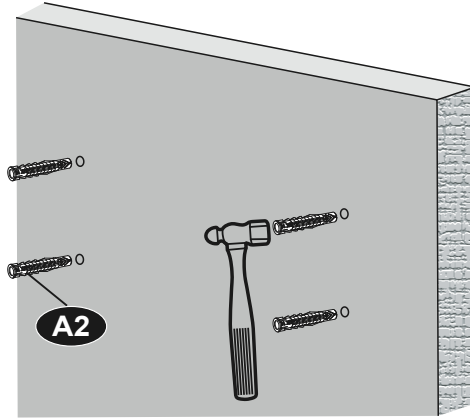

l h] ^] WY ^ Y ^ a U f h] ^ ^ c ^ d U f U ^ [c ^ d Y d W f f ^ Y ^ X c ^ g ^
5 g Y [^ f Y g Y ^ X Y ^ e i Y ^ ^ c g ^ 5 b W ^ U g ^ X Y ^ d U f Y X
g i d Y f ^ W] Y ^ X Y ^ \ c f a] [D b ^ "

2B-4

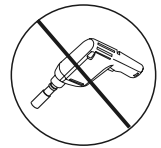
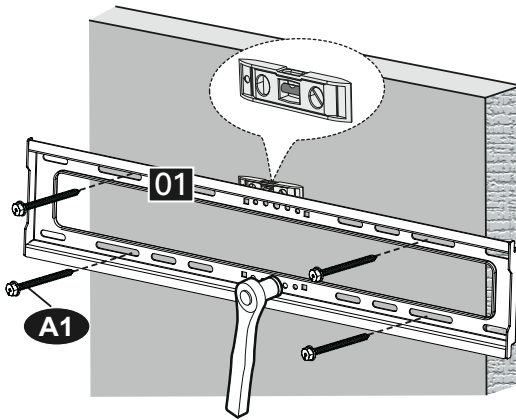

= b g h U ^ Y ^ ^ U ^ d ^ U W U ^ X Y ^ d U f Y X ^ O \$ % Q ^ ^ W c b ^ ^ ^
5 ^ i g h Y ^ ^ c g ^ h c f b] ^ ^ c g ^ X Y ^ f Y h f U - g c ^ O 5 % Q
h c g ^ U ^ ^ U ^ d ^ U W U ^ X Y ^ d U f Y X ^ O \$ % Q ^ ^ B c ^ U ^ i
X Y ^ f Y h f U g c ^ O 5 % Q ^ "

Nota: No utilice un taladro para ajustar los tornillos de retraso. Utilice únicamente una llave de tubo.

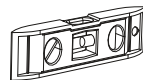

Nivel
(No se incluye)





1/2 pulg (13mm)
Llave de tubo
(No se incluye)

Paso 3 Fije el televisor en la placa de pared

Para colgar el televisor en la placa de pared

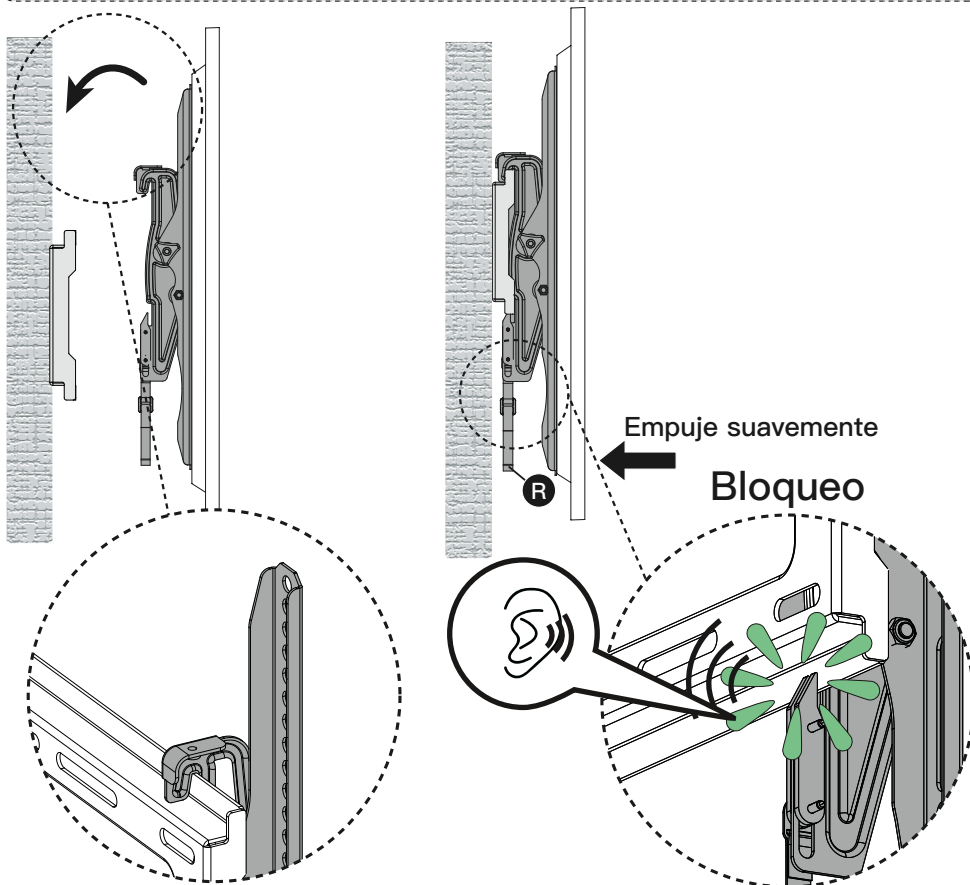
1. Cuelgue el televisor con los soportes [02] y [03] en la placa de pared.
2. Presione suavemente la parte inferior del televisor hacia la pared hasta que oiga el "clic" de las cerraduras de seguridad en ambos lados del soporte.



  **¡OBJETO PESADO!** Es posible que necesite asistencia en este paso.

Precaución: para evitar posibles lesiones y daños materiales, el televisor debe ser sacado del soporte por dos personas.

1. Revise que todos los cables estén desconectados de la parte posterior del televisor y que éste esté desenchufado de la pared.
2. Mientras presiona suavemente la parte delantera del televisor hacia la pared, tire las correas de seguridad hacia abajo hasta que se desenganchen por completo.
3. Mientras mantiene las correas desenganchadas, aleje la parte inferior del televisor de la pared y levántelo de la placa de pared.

Hardware suministrado para el paso 4



13/64 pulg (5mm)
Llave Allen

x1

Paso 4 Ajuste

Ajuste de la inclinación

1. Utilice las perillas de tensión en los lados de los Soportes para TV para ajustar el televisor a la posición deseada.
2. Después de realizar cualquier ajuste, vuelva a ajustar las perillas de tensión para mantener el televisor en su sitio y evitar movimientos no deseados.

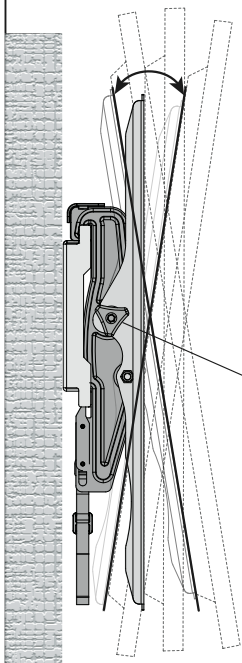

⚠ PRECAUCIÓN!

A c U ^ i g h Y b U c ^ Y
perillas en exceso.

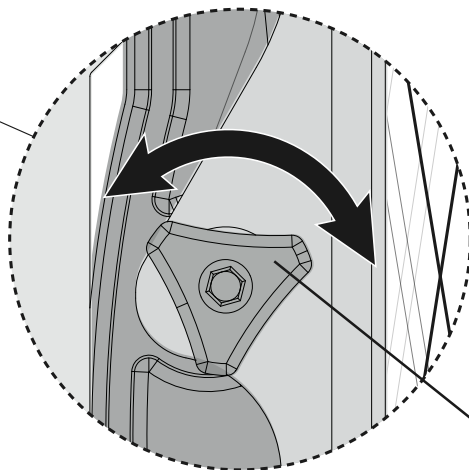

K



13/64 pulg (5mm)
Llave Allen

ERGOAV™

At ErgoAV, we strive to provide the highest valued products.
We want to support your purchase.

= Z ` m c i ` \ U j Y ` e i Y g h] c b g W c b V
or feedback please let us know!

ErgoAV Customer Care
Phone (877) 419-7832 M-F 8am to 8pm CST
support@ergoav.com

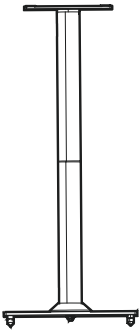

Speaker Stands

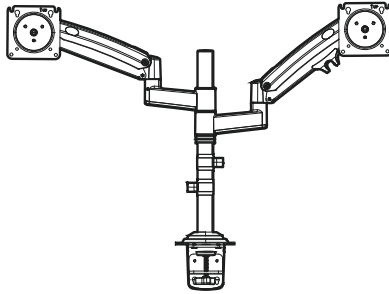

Computer Monitor Mounts

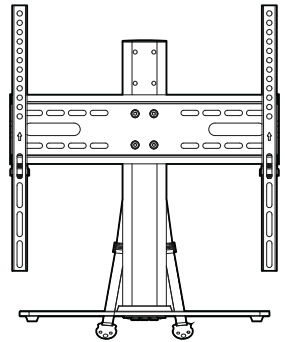

TV Stand

9501 Louisiana Ave N, #200, Brooklyn Park, MN 55445
WWW.ERGOAV.COM