



## TV Mount Instruction Manual

(A)

English pages 02–14

French pages 15–27

Spanish pages 28–40

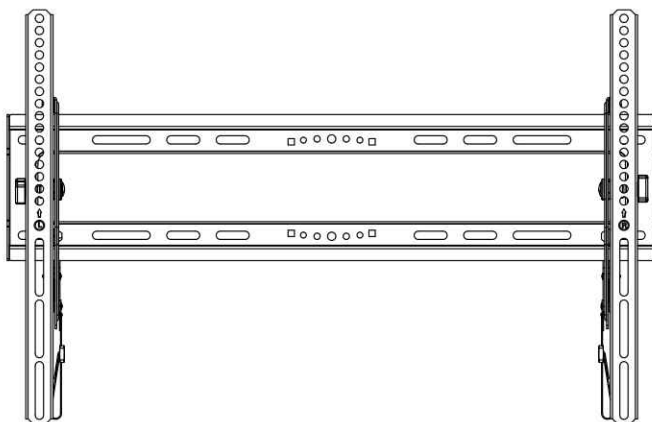

**Model: ERMTL1-01B**

**THANK YOU FOR CHOOSING THIS ERGOAV PRODUCT!**

At ErgoAV, we want to add value to your AV experience by providing the highest quality products and services in the industry. If you have any concerns or comments, please contact us.

ErgoAV Customer Care

Phone (877) 419-7832 M-F 8am to 8pm CST

email: [support@ergoav.com](mailto:support@ergoav.com)

website: [www.ergoav.com](http://www.ergoav.com)

address: 9501 Louisiana Ave N, #200 Brooklyn Park, MN 55445

## IMPORTANT SAFETY INFORMATION

**⚠ DANGER!** Please carefully read all instructions before attempting installation. If you do not understand the instructions or have any concerns or questions, please contact our Technical Support line at (877) 419-7832 or customer service at support@ergoav.com.

**⚠ CAUTION:** Use with products heavier than the maximum weights indicated may result in instability causing possible injury.

- Do not use this product for any purpose that is not explicitly specified in this manual. Do not exceed weight capacity. We are not liable for damage or injury caused by improper mounting, incorrect assembly or inappropriate use.
- This product is designed for use in wood stud, and solid concrete walls. – DO NOT install into drywall alone.
- The wall must be capable of supporting four times the weight of the TV and mount combined.
- Use this mounting system only for its intended use as described in these instructions. Do not use attachments not recommended by the manufacturer.
- Do not use outdoors.
- Route cords and cables properly to avoid mechanical damage.
- SAVE THESE INSTRUCTIONS.

## Weight Restrictions



If your TV weighs more, do not use this product.

### ⚠ WARNING

DO NOT exceed the maximum weight indicated. This mounting system is intended for use only within the maximum weights indicated. Use with products heavier than the maximum weights indicated may result in failure of the mount and its accessories, causing damage and or injury.

## Check the VESA Pattern of Your TV before the Installation

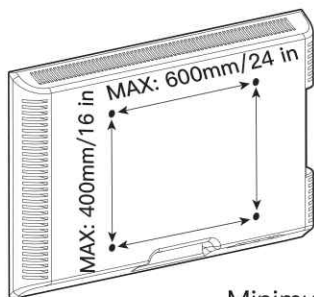

100 mm  $\approx$  4 in  
200 mm  $\approx$  7 7/8 in  
400 mm  $\approx$  15 3/4 in  
600 mm  $\approx$  23 5/8 in

Minimum VESA pattern: 200mm/8 in (W)x100mm/4 in (H)

If your TV VESA is greater than 600x400 mm/24x16 in or less than VESA 200x100mm/8x4 in, this mount is NOT compatible.

If this mount is NOT compatible, please contact our Technical Support line at (877) 419-7832 or customer service at support@ergoav.com to find a compatible mount.

## Tools Needed (Not Included)



Stud Finder



Awl



Tape Measure



Pencil



Electric Drill



Level



7/32 in (5.5mm)  
Wood Drill



1/2 in (13mm)  
Socket Wrench



Phillips  
Screwdriver

(Needed for concrete installs)



3/8 in (10mm)  
Concrete Drill



Hammer

## Verify Your Wall Construction



**CAUTION**

DO NOT  
install into  
drywall alone

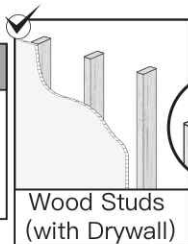

Wood Studs  
(with Drywall)

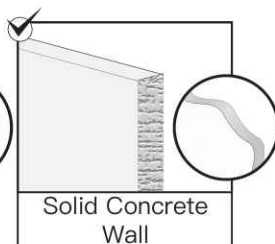

Solid Concrete  
Wall

If you are not sure of the wall construction, please contact our Technical Support line at (877) 419-7832 or customer service at [support@ergoav.com](mailto:support@ergoav.com).

## Supplied Parts and Hardware

- ⚠ Warning:** This product contains small items that could be a choking hazard if swallowed. Before starting assembly, verify all parts are included and undamaged. Do not use damaged or defective parts. If you require replacement parts, please contact our Technical Support line at (877) 419-7832 or customer service at [support@ergoav.com](mailto:support@ergoav.com)
- Please note: Not all hardware included in this package will be used.

## Supplied Parts and Hardware for Step 1

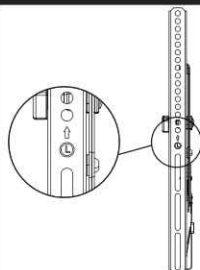

Left TV Bracket  
**02** x1

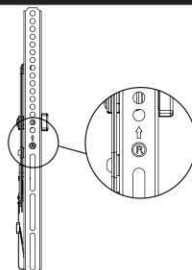

Right TV Bracket  
**03** x1

### Spacers

**NOTE:** The spacers are shown in actual size.

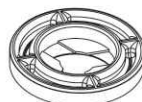

L2.5mm  
**F1** x8

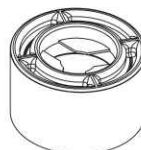

L10mm  
**F2** x4



L22mm  
**F3** x4

Washer



M4/M5  
**B1** x4

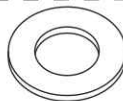

M6/M8  
**B2** x4

## TV Bolts [Only one bolt size fits your TV]

NOTE: The bolts are shown in actual size

M4

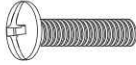

M4x12mm  
**C1** x4

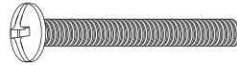

M4x30mm  
**C2** x4

M6

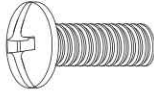

M6x15mm  
**D1** x4

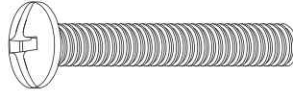

M6x35mm  
**D2** x4

M8

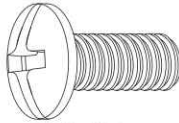

M8x15mm  
**E1** x4

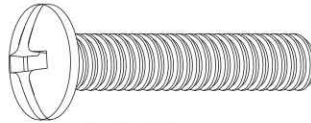

M8x35mm  
**E2** x4

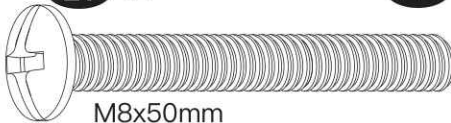

M8x50mm  
**E3** x4

## Step 1 Secure the TV Brackets to the TV

### Select TV Bolts

Only one bolt size fits your TV.

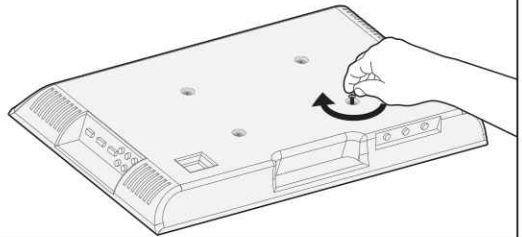
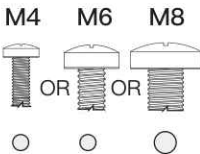

Bolt length: Verify adequate thread engagement with bolts or bolts/spacers combination. We recommend thread engagement by at least 5 turns.

-Too short will not hold the TV.

-Too long will damage the TV.

Note: Please do not over tighten the TV bolts to avoid damaging your TV.

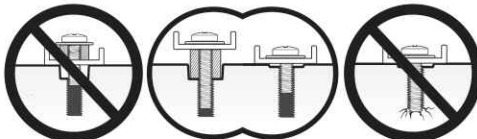

Too short

Correct

Too long

**Please Note:** When using the spacers it is important to note that they can be used in multi-layers (meaning stacked). If you have any difficulty understanding how to install the TV bolts or spacers, please contact our Technical Support line at (877) 419-7832 or customer service at support@ergoav.com.

## Parts Needed if You Have a TV as Shown Below

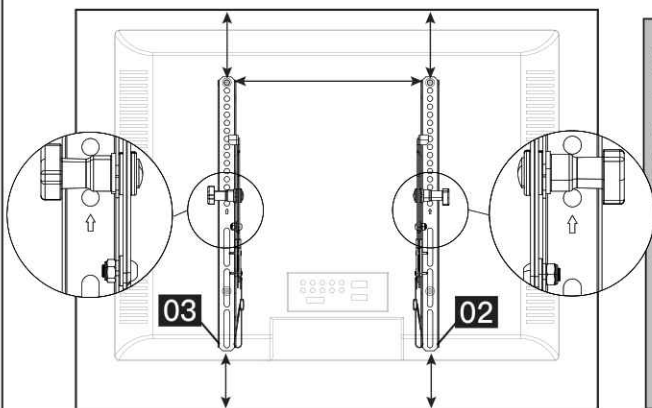
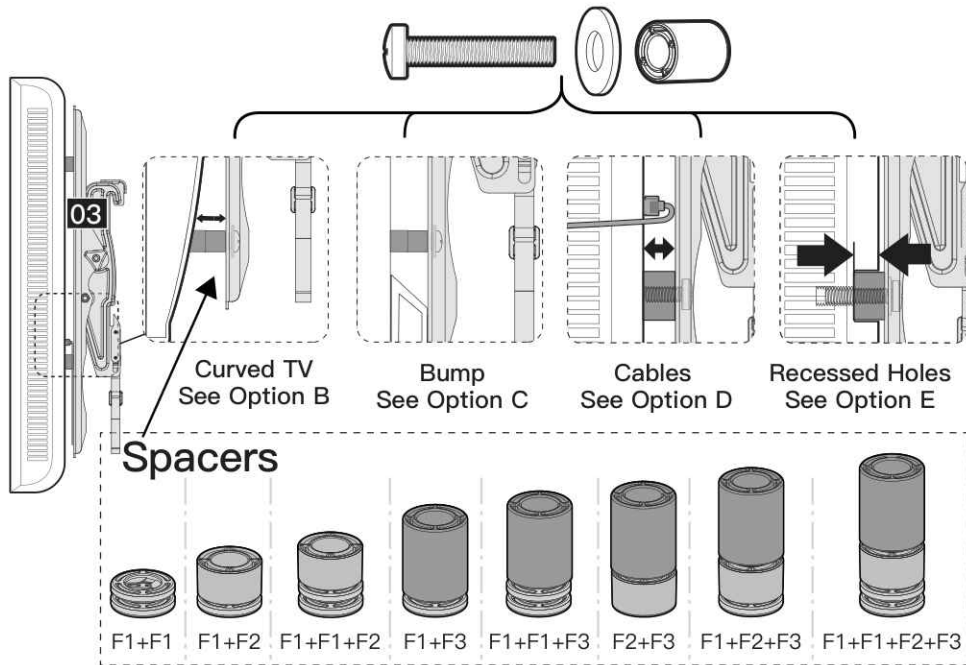

**CAUTION:** When attaching the TV brackets to the back of the TV, ensure the Up Arrows are pointing to the top of the TV and are equally centered on the back of the TV.

**PLEASE NOTE:** The bolt hole locations on your TV may vary in accordance of the manufacturers design of the TV. We are only illustrating possible locations of the bolt holes.



### Option C (For TV with A “Bump”)

Spacers must be tall enough so there is no gap between TV bracket and bump on the back of the TV.

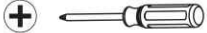
 Phillips Screwdriver  
(Not Included)

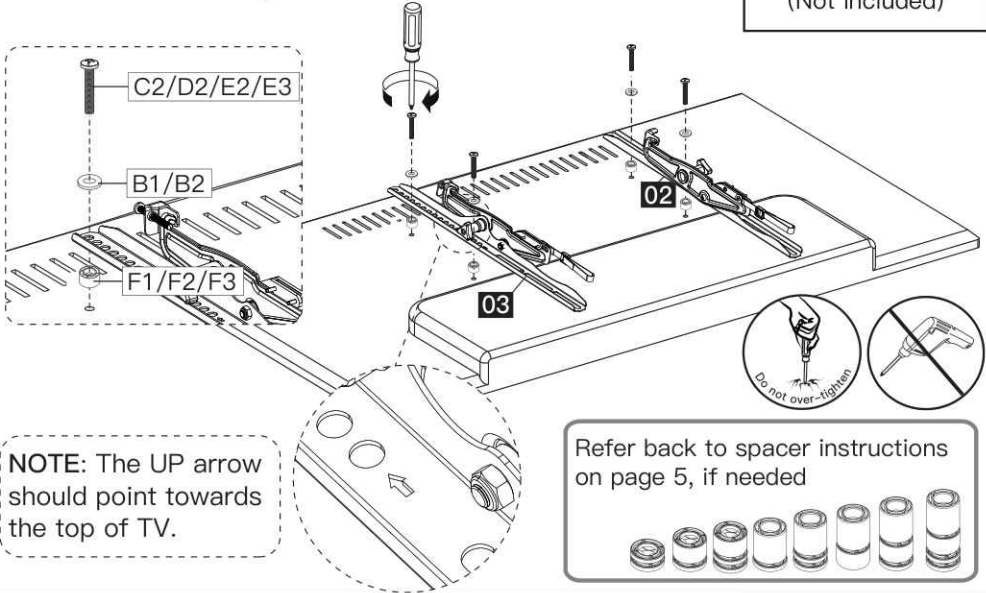

### Option D (for TV with Cable Interference)

For cable interference, use spacers [F1], [F2] and [F3] to create extra space between the TV and TV brackets.

 Phillips Screwdriver  
(Not Included)

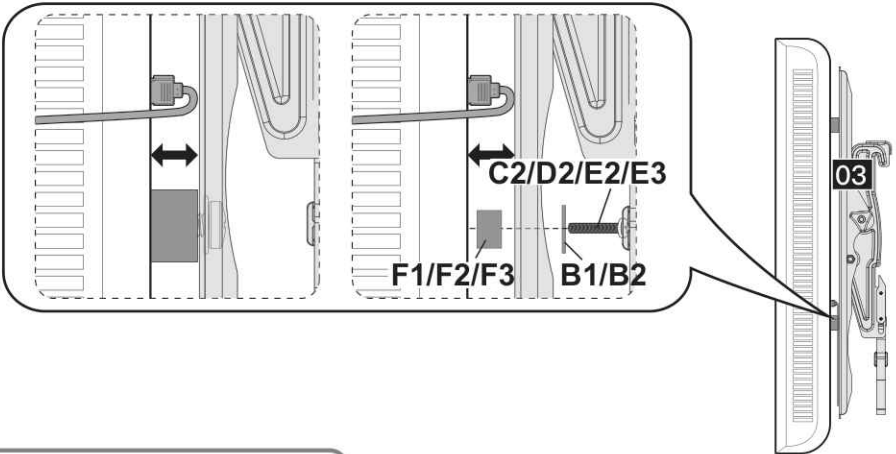

## Option E (For Recessed Holes )

The spacer needs to fill in the recessed holes on the back of the TV so that the TV brackets are as close to the TV as possible.



Phillips Screwdriver  
(Not Included)

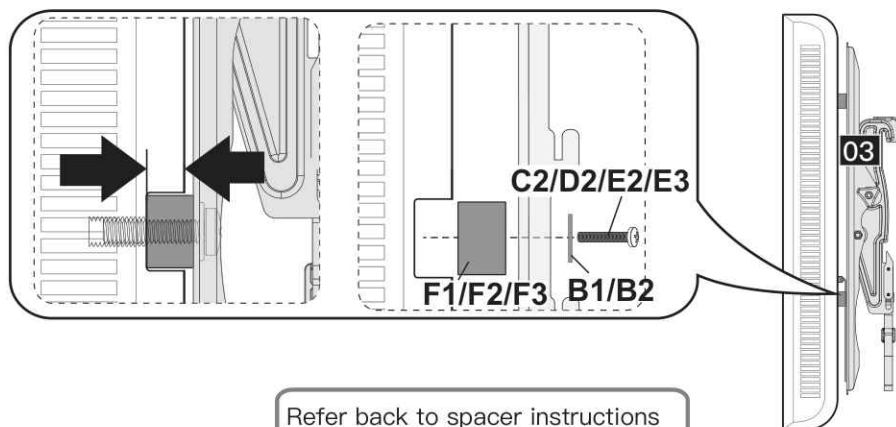

Refer back to spacer instructions  
on page 5, if needed



## Supplied Parts and Hardware for Step 2

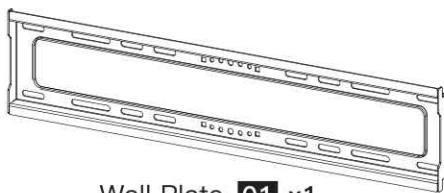

Wall Plate **01** x1

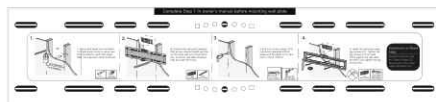

Wall Plate Template **04** x1

Note: The lag screw is shown in actual size

**A1** x4

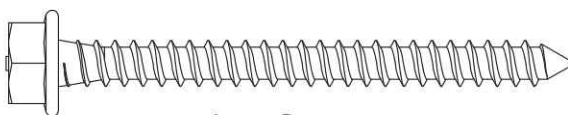

Lag Screw  
5/16X2 3/4 in

**A2**

x4

Wall  
Anchor  
10X60mm

### ! CAUTION!

This anchor is for concrete walls ONLY. DO NOT use them in drywall or wood studs.

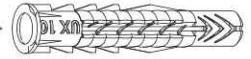

## Step 2 Attach the Wall Plate [01] to the Wall

For wood stud installation, follow STEP 2A

For concrete installation, follow STEP 2B

### Step 2A Wood Stud Option

#### ! WARNING:

Do not use a drill for tightening the lag screws! Only use a socket wrench.

Avoid potential personal injury or property damage! DO NOT over-tighten the lag screws [A1]. Tighten the lag screws [A1] only until they are pulled firmly against the wall plate [01].

**DO NOT USE ANCHOR [A2] FOR THIS STEP.**

Ensure the wall plate is securely fastened to the wall before continuing to the next step.

- Nominal wood stud size: common 2 x 4 in (51 x 102 mm)
- Stud center must be verified.



#### 2A-1

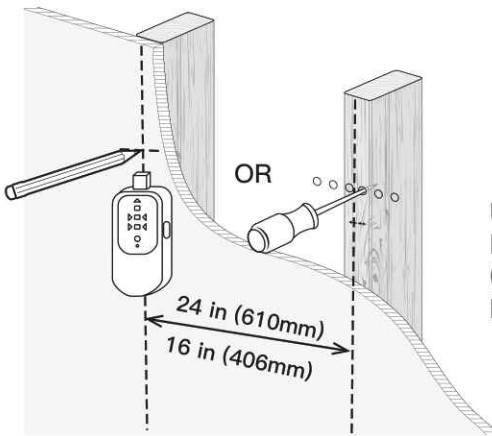

Stud finder  
(Not Included)



Awl  
(Not Included)

Use a stud finder (not included) to locate wood studs or use an awl (not included) to verify the edges. Mark the edge and center locations.

## 2A-2

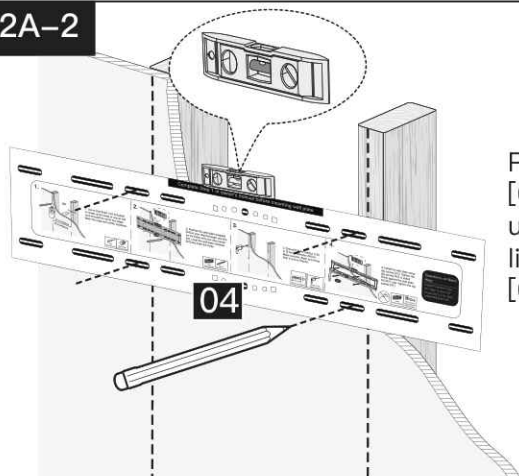

Position the wall plate template [04] at your desired height and line up the holes with your stud center line. Level the wall plate template [04] and mark the holes.

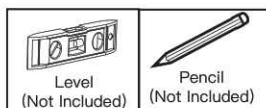

## 2A-3

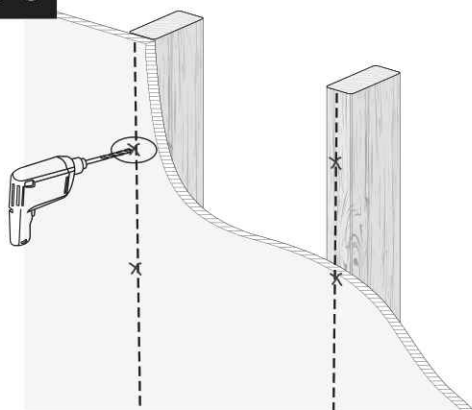

Drill pilot holes using a 7/32 in (5.5mm) diameter drill bit. Make sure the depth is not less than 2 3/4 in (70mm).

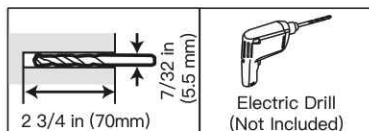

## 2A-4

Note: Do not use a drill to tighten the lag screws. Only use a socket wrench.

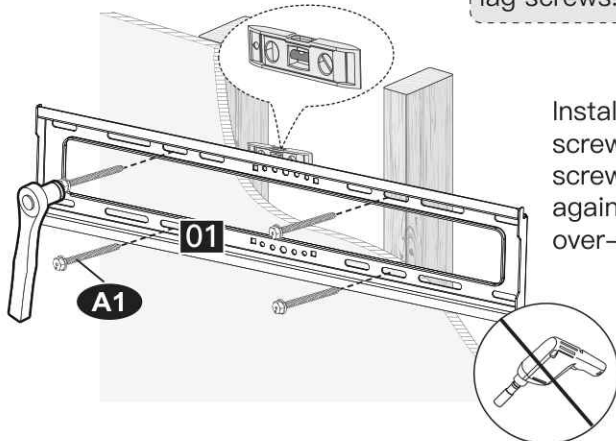

Install the wall plate using lag screws [A1]. Tighten the lag screws [A1] is pulled firmly against the wall plate. DO NOT over-tighten the lag screws [A1].

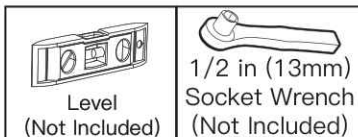

## Step 2B Solid Concrete Wall Option

### **⚠ WARNING:**

Do not use a drill for tightening the lag screws! Only use a socket wrench.

- Avoid potential personal injury or property damage! DO NOT over-tighten the lag screws [A1]. Tighten the lag screws [A1] is pulled firmly against the wall plate.
- Ensure the wall plate is securely fastened to the wall before continuing to the next step.
- Mount the wall plate directly onto the concrete surface without any covering.
- The thickness of the concrete wall must exceed 5.5 in (140 mm).



Wall Anchor

**A2**

### 2B-1

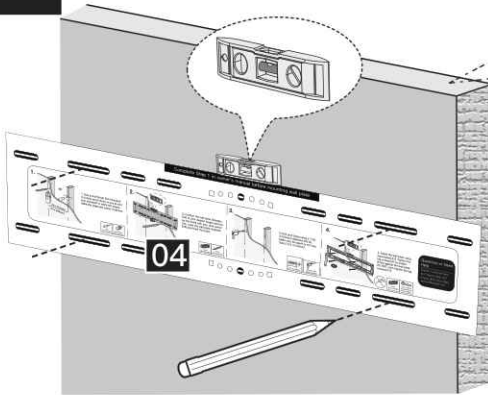

Wall Thickness  
≥5.5 in  
(140mm)

Position the wall plate template [04] at your desired height. Level the wall plate template [04] and mark the pilot hole locations.

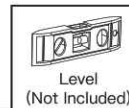

Level  
(Not Included)



Pencil  
(Not Included)

### 2B-2

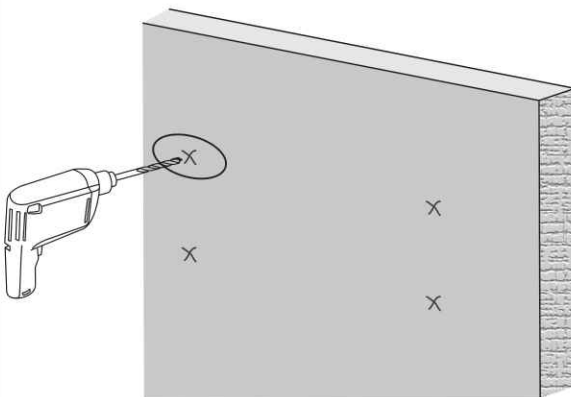

Drill 4 pilot holes using a 3/8 in (10mm) diameter drill bit. Make sure the depth is not less than 3 in (75mm).



Electric Drill  
(Not Included)

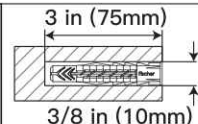

## 2B-3



Hammer  
(Not Included)

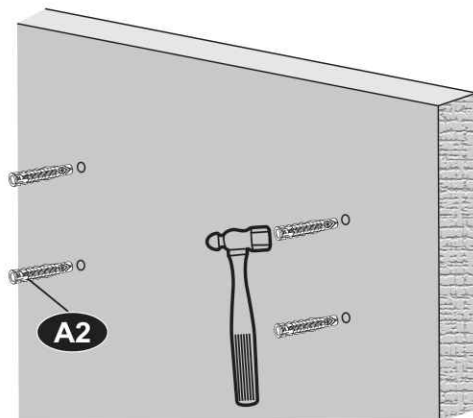

Use the hammer to knock anchors [A2] into the wall. Be sure the anchors [A2] are seated flush with the concrete surface.

## 2B-4

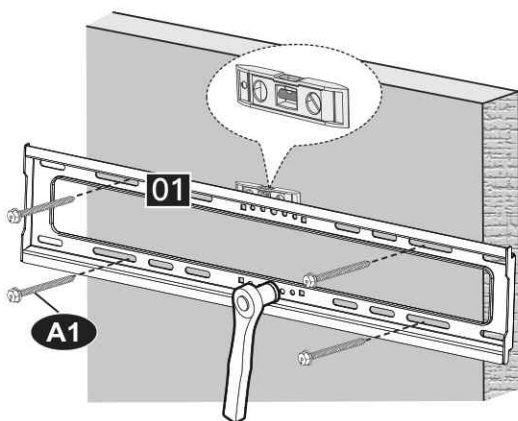

Install the wall plate [01] using lag screws [A1]. Tighten the lag screws [A1] is pulled firmly against the wall plate [01]. DO NOT over-tighten the lag screws [A1].

Note: Do not use a drill to tighten the lag screws. Only use a socket wrench.

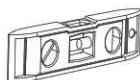

Level  
(Not Included)



1/2 in (13mm)  
Socket Wrench  
(Not Included)

## Step 3 Secure the TV onto the Wall Plate

### To Hang TV onto the Wall Plate

1. Hang the TV with brackets [02] and [03] onto the wall plate.
2. Gently press the bottom of the TV towards the wall until you hear the safety locks “click” into place on both sides of the mount.

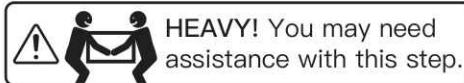
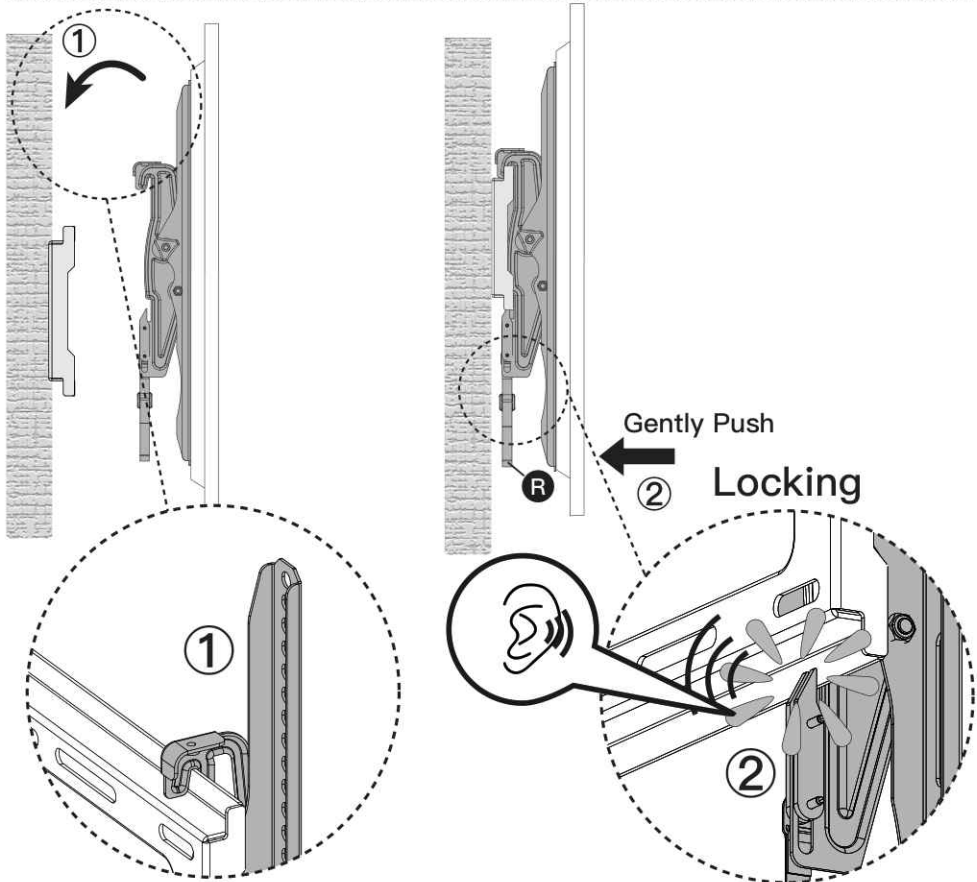

**Caution:** to avoid potential injury and person property damage, two people should assist in removing the TV from the mount.

1. Verify that all cables are disconnected from the back of the TV and the TV is unplugged from wall.
2. While gently applying pressure to the front of the TV towards the wall, pull down on the safety straps until they are full disengaged.
3. While keeping the straps in the disengaged position, move the bottom of the TV away from the wall and lift the TV off the wall plate.

## Supplied Hardware for Step 4



3/16 in (5mm)  
Allen Key

x1

## Step 4 Adjustment

### Tilt Adjustment

1. Use tension knobs on the sides of the TV brackets to allow adjustment of the TV to desired position.
2. After making any adjustments, always re-tighten the tension knobs to hold TV in place and avoid unwanted movement.

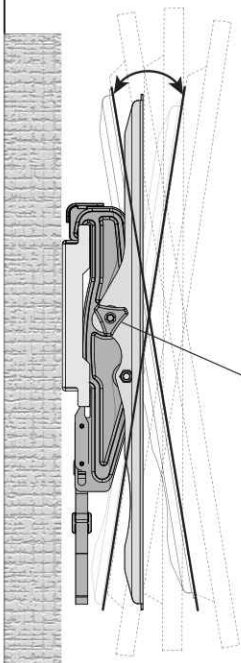

### **⚠ CAUTION!**

Please do not over-tighten  
or over-loosen the knobs.

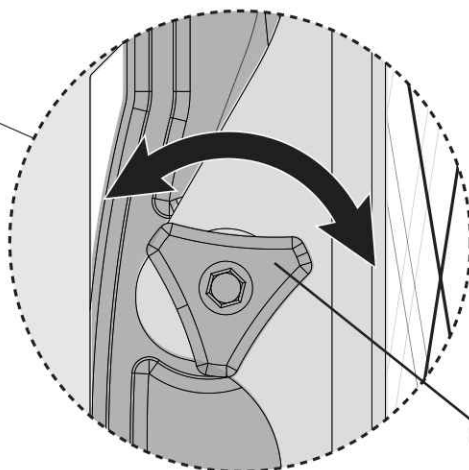

**K**



3/16 in (5mm)  
Allen Key

## Consignes de sécurité importantes

**⚠ DANGER !** Veuillez lire attentivement toutes les instructions avant de tenter l'installation. Si les instructions ne vous semblent pas claires ou si vous avez des questions, veuillez contacter notre service d'assistance technique au (877) 419-7832 ou notre service clientèle à l'adresse [support@ergoav.com](mailto:support@ergoav.com).

**⚠ ATTENTION:** L'utilisation avec des produits plus lourds que les poids maximums indiqués peut entraîner une instabilité et des blessures possibles.

- N'utilisez pas ce produit à des fins qui ne sont pas explicitement spécifiées dans ce manuel. Ne dépassez pas la capacité de charge. Nous ne sommes pas responsables des dommages ou blessures causés par un montage incorrect, un assemblage incorrect ou une utilisation inappropriée.
- Ce produit est conçu pour être utilisé dans les murs à ossature de bois et les murs en béton massif. – NE PAS installer dans une cloison sèche seule.
- Le mur doit être capable de supporter quatre fois le poids du téléviseur et du support combinés.
- Utilisez ce système de montage uniquement pour l'usage auquel il est destiné, tel que décrit dans ces instructions. N'utilisez pas d'accessoires non recommandés par le fabricant.
- Ne pas utiliser à l'extérieur.
- Achetez correctement les cordons et les câbles pour éviter tout dommage mécanique.
- SAUVEGARDER CES INSTRUCTIONS.

## Restrictions de poids



Si votre téléviseur pèse plus lourd, n'utilisez pas ce produit.

### ⚠ AVERTISSEMENT

NE PAS dépasser le poids maximum indiqué. Ce support TV est destinée à être utilisé uniquement dans la limite des poids maximums indiqués. L'utilisation de produits plus lourds que les poids maximums indiqués peuvent entraîner une défaillance du support TV et de ses accessoires, et provoquer des dommages et/ou des blessures.

## Vérifiez le modèle VESA du TV avant l'installation

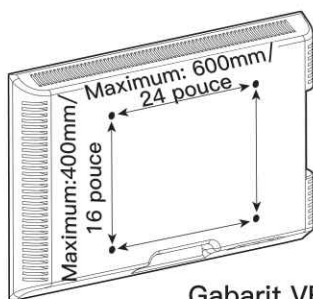

100 mm ≈ 4 pouce  
200 mm ≈ 7 7/8 pouce  
400 mm ≈ 15 3/4 pouce  
600 mm ≈ 23 5/8 pouce

**Gabarit VESA minimal: 200mmx100mm/8 pouce x 4 pouce**

Si le gabarit VESA de votre téléviseur mesure plus de 600x400mm/24x16 pouce ou moins de 200x100mm/8x4 pouce, ce support de téléviseur N'EST PAS compatible.

Si ce support n'est PAS compatible, veuillez contacter notre ligne d'assistance technique au (877) 419-7832 ou notre service clientèle à l'adresse [support@ergoav.com](mailto:support@ergoav.com) pour trouver un support compatible.

## Outils nécessaires (non inclus)



Détecteur de goujons



Ailette



Mètre ruban



Crayon



Foreuse



Niveau



7/32 pouce (5.5mm)  
Foret à bois

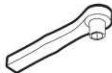

1/2 pouce (13mm)  
Clé à douille



Tournevis Phillips

(Nécessaire pour les installations en béton)



3/8 pouce (10mm)  
Foret à béton



Marteau-piqueur

## Vérifiez la construction de vos murs



**NE PAS**  
installer dans  
une cloison  
sèche seule

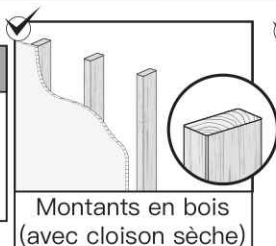

Montants en bois  
(avec cloison sèche)

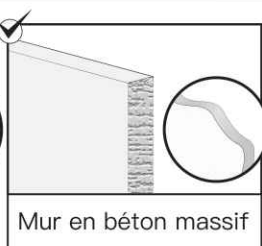

Mur en béton massif

Si vous n'êtes pas sûr de la construction du mur, veuillez contacter notre ligne d'assistance technique au (877) 419-7832 ou notre service clientèle à l'adresse [support@ergoav.com](mailto:support@ergoav.com).

## Pièces et matériel fournis

**AVERTISSEMENT:** Ce produit contient des petits objets susceptibles de présenter un risque d'étouffement en cas d'ingestion.

Avant de commencer l'assemblage, vérifiez que toutes les pièces sont incluses et en bon état. N'utilisez pas de pièces endommagées ou défectueuses. Si vous avez besoin de pièces de rechange, veuillez contacter notre ligne d'assistance technique au (877) 419-7832 ou notre service clientèle à l'adresse [support@ergoav.com](mailto:support@ergoav.com).

• Veuillez noter : le matériel inclus dans cet ensemble ne sera pas utilisé en totalité.

## Pièces et matériel fournis pour l'étape 1

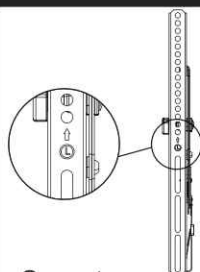

Soporte para TV derecho  
**02** x1

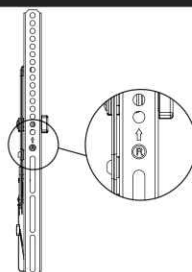

Support TV droit  
**03** x1

### Entretoises

**Remarque:** Les entretoises sont présentées en taille réelle.

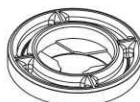

L2.5mm  
**F1** x8



L10mm  
**F2** x4

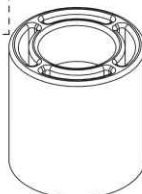

L22mm  
**F3** x4

Rondelle



M4/M5  
**B1** x4



M6/M8  
**B2** x4

## Boulons de téléviseur [Une seule taille de boulon convient à votre téléviseur]

Remarque: Les boulons sont représentés en taille réelle

M4

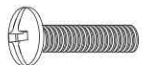

M4x12mm

**C1** x4



M4x30mm

**C2** x4

M6

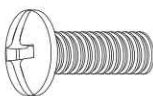

M6x15mm

**D1** x4

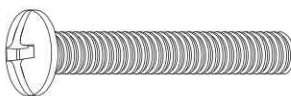

M6x35mm

**D2** x4

M8

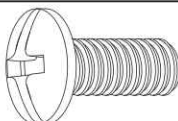

M8x15mm

**E1** x4

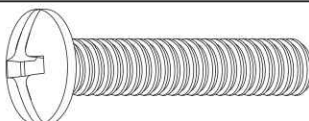

M8x35mm

**E2** x4

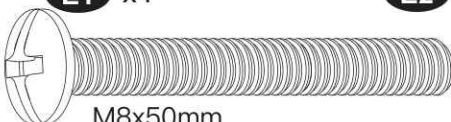

M8x50mm

**E3** x4

## Étape 1 Fixez les supports du téléviseur sur le téléviseur

### Sélectionnez les boulons TV

Une seule taille de boulon convient à votre téléviseur.

M4 M6 M8

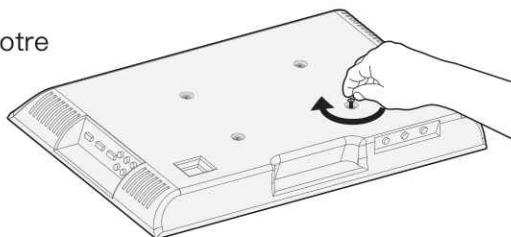
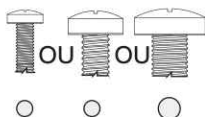

Longueur de la boulon : Vérifiez que le filetage est correctement engagé avec les boulons ou la combinaison boulons/entretoises. Nous recommandons un engagement du filetage sur au moins 5 tours.

- Trop court, le téléviseur ne sera pas maintenu.
- Trop long, le téléviseur sera endommagé.

Remarque : Ne serrez pas trop les boulons de téléviseur pour ne pas l'endommager.

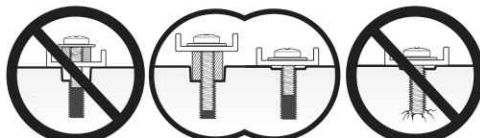

Trop court

Correct

Trop long

**Veillez noter:** Lors de l'utilisation des entretoises, il est important de noter qu'elles peuvent être utilisées sur plusieurs couches (c'est-à-dire empilées). Si vous rencontrez des difficultés pour comprendre comment installer les boulons ou les entretoises du téléviseur, veuillez contacter notre service d'assistance technique au (877) 419-7832 ou notre service clientèle à l'adresse support@ergoav.com.

## Les pièces nécessaires si vous avez un téléviseur tel qu'in- diqué ci-après

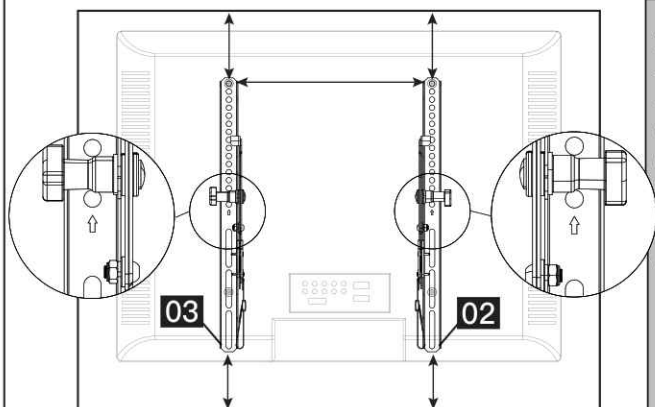
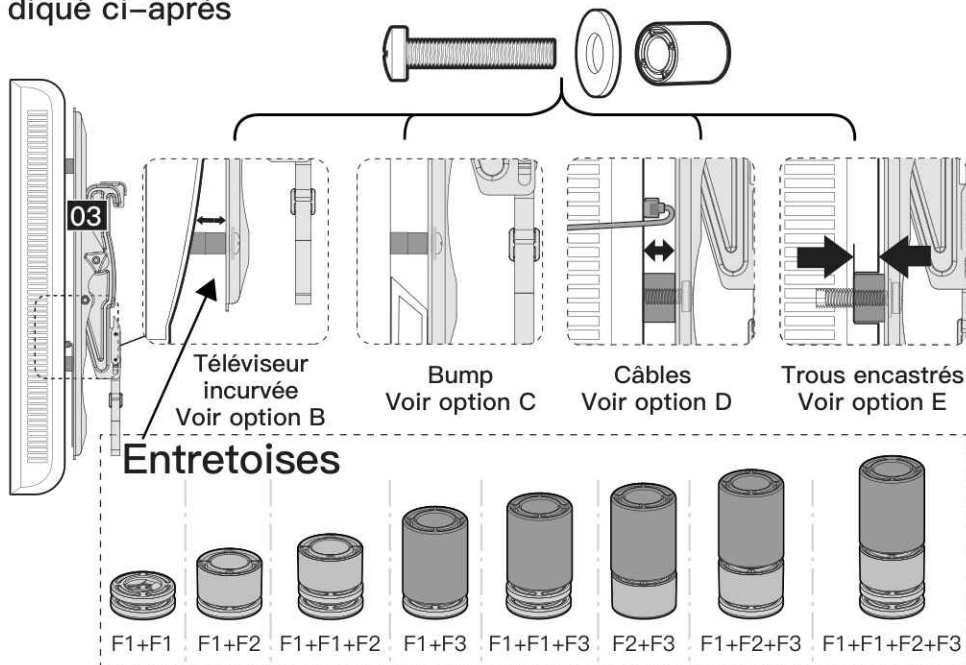

**⚠ ATTENTION:** Lorsque vous fixez les supports TV à l'arrière du téléviseur, assurez-vous que les flèches vers le haut sont dirigées vers le haut du téléviseur et qu'elles sont également centrées sur l'arrière du téléviseur.

**⚠ EUILLEZ NOTER:** Les emplacements des trous de boulon sur votre téléviseur peuvent varier en fonction du design du fabricant du téléviseur. Nous représentons seulement les emplacements possibles des trous des boulon.

## Option A (pour un téléviseur à dos plat)

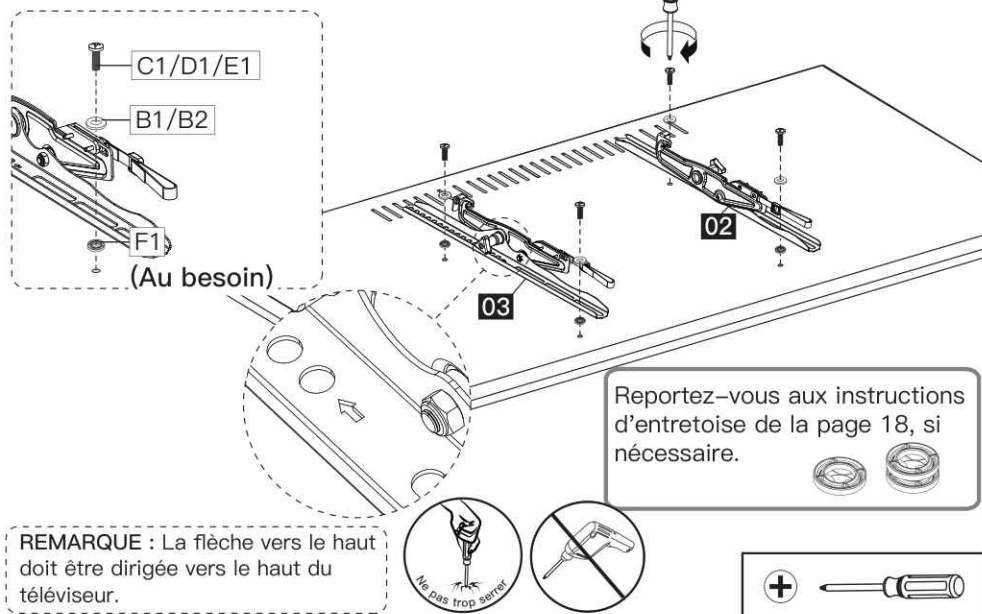

## Option B (pour un téléviseur à dos arrondi)

La hauteur des entretoises doit être suffisante pour éviter que la courbe à l'arrière du téléviseur n'interfère avec la plaque de montage.

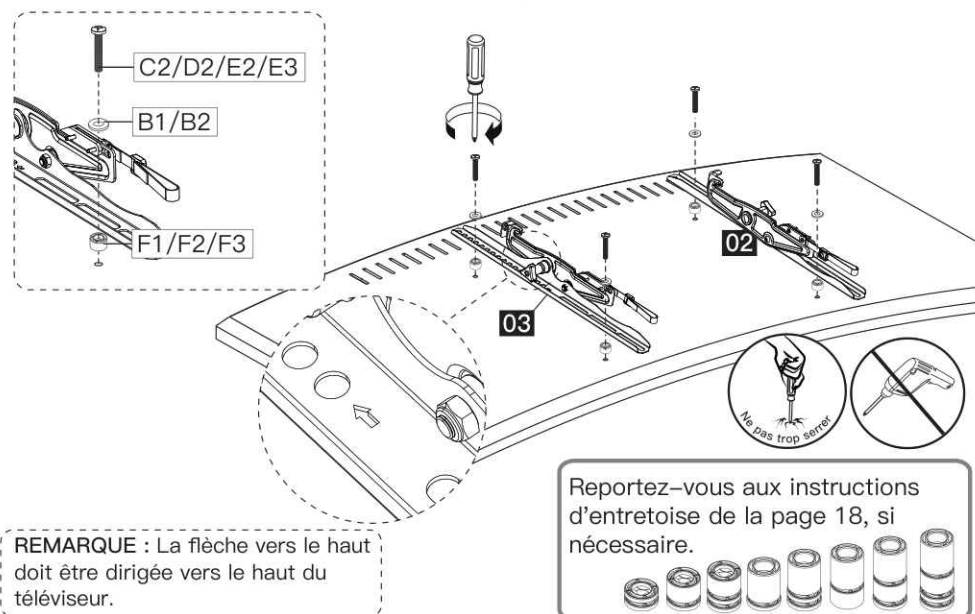

### Option C (pour un téléviseur avec une surépaisseur)

Les entretoises doivent être suffisamment hautes pour qu'il n'y ait pas d'espace entre le support TV et la bosse à l'arrière du Téléviseur.



Tournevis Phillips  
(Non inclus)

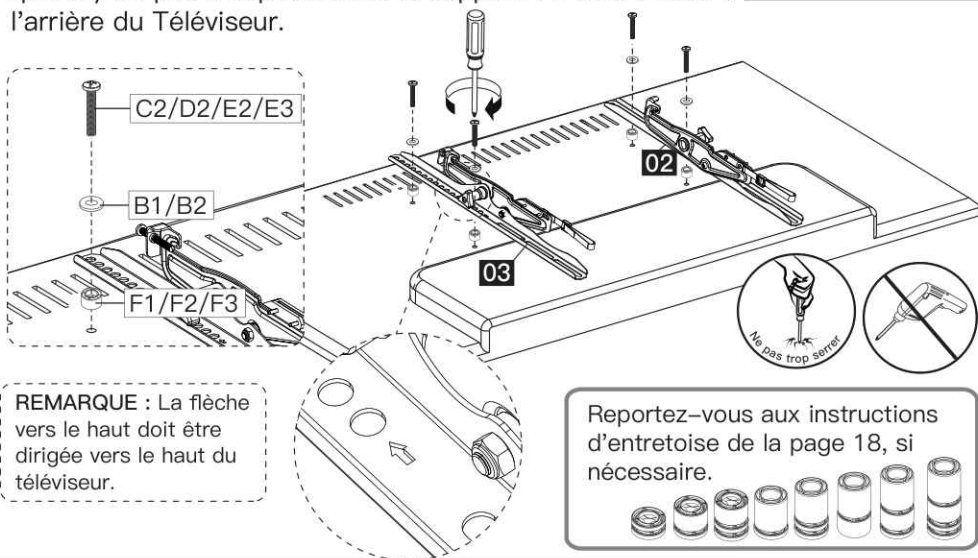

REMARQUE : La flèche vers le haut doit être dirigée vers le haut du téléviseur.

Reportez-vous aux instructions d'entretoise de la page 18, si nécessaire.



### Option D (pour téléviseur avec interférence du câble)

Pour éviter les interférences entre les câbles, utilisez les entretoises [F1], [F2] et [F3] pour créer un espace supplémentaire entre le téléviseur et les supports TV.

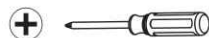

Tournevis Phillips  
(Non inclus)

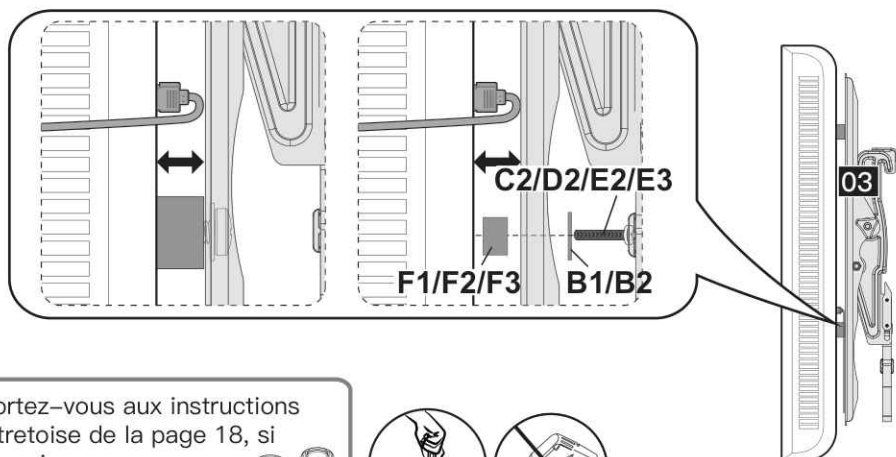

Reportez-vous aux instructions d'entretoise de la page 18, si nécessaire.



## Option E (Pour les trous encastrés)

L'entretoise doit remplir les trous en retrait sur la base du téléviseur afin que les supports TV soient aussi proches que possible du téléviseur.



Tournevis Phillips  
(Non inclus)

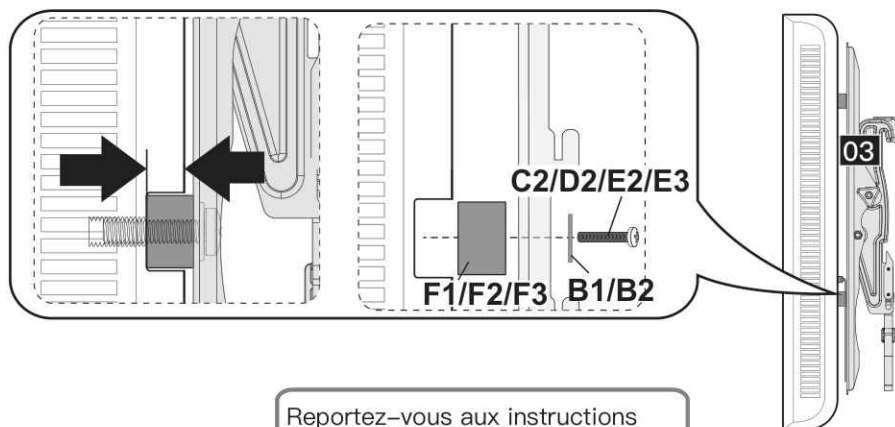

Reportez-vous aux instructions d'entretoise de la page 18, si nécessaire.



## Pièces et matériel fournis pour l'étape 2

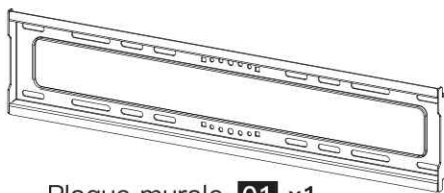

Plaque murale **01** x1

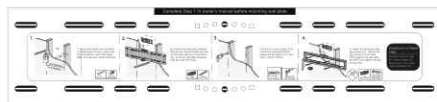

Modèle de mur **04** x1

Remarque : Le tire-fond est représenté en taille réelle

**A1** x4

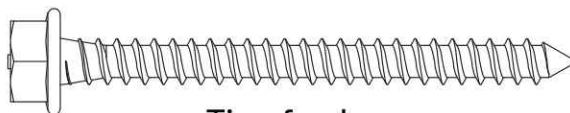

Tire-fond  
5/16X2 3/4 pouce

**A2** x4 Ancre de mur  
10X60mm

**! ATTENTION!**  
Cet ancrage est destiné aux  
murs en béton UNIQUE-  
MENT. NE PAS les utiliser  
dans des cloisons sèches ou  
les montants en bois.



## Étape 2 Fixer la plaque murale [01] au mur

Pour l'installation de montants en bois, suivre l'ÉTAPE 2A.  
Pour l'installation de béton, suivre l'ÉTAPE 2B.

### Étape 2A Option montants en bois

#### **! AVERTISSEMENT:**

N'utilisez pas de perceuse pour serrer les tire-fonds ! Utilisez uniquement une clé à douille.

Évitez les blessures corporelles ou les dommages matériels potentiels ! NE SERREZ PAS trop les tire-fonds [A1]. Serrez les tire-fonds [A1] et tirez-les fermement contre la plaque murale.

**NE PAS UTILISER L'ANCRAGE [A2] POUR CETTE ÉTAPE.**

Assurez-vous que la plaque murale est bien fixée au mur avant de passer à l'étape suivante.



- Taille nominale des montants en bois: commun 2 x 4 pouce (51 x 102 mm)
- Le centre des montants doit être vérifié.

#### 2A-1

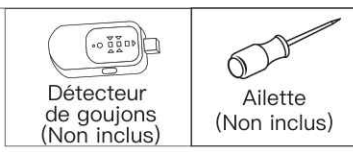
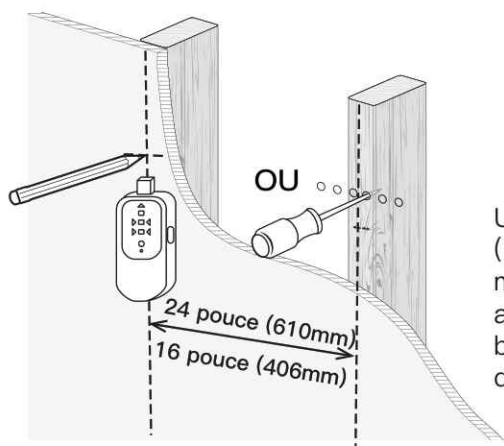

Utilisez un détecteur de montants (non inclus) pour localiser les montants en bois ou utilisez une alène (non incluse) pour vérifier les bords. Marquez les emplacements du bord et du centre.

2A-2

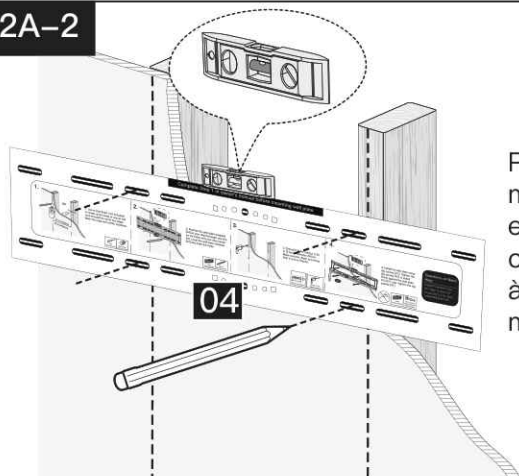

Positionnez le modèle de plaque murale [04] à la hauteur souhaitée et alignez les trous avec la ligne centrale de votre montant. Mettez à niveau le modèle de plaque murale [04] et marquez les trous.



Niveau  
(Non inclus)



Crayon  
(Non inclus)

2A-3

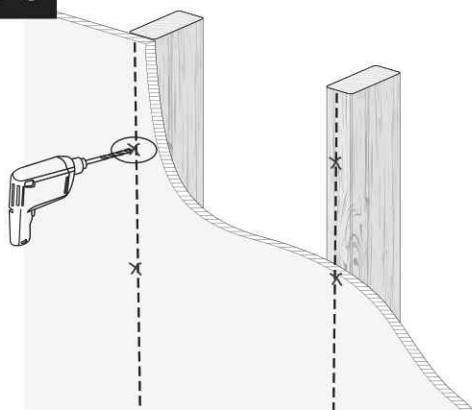

Percez des trous pilotes à l'aide d'un foret de 7/32 pouce (5,5 mm) de diamètre. Assurez-vous que la profondeur n'est pas inférieure à 2 3/4 pouce (70 mm).

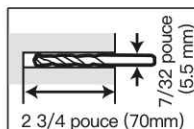

Foreuse  
(Non inclus)

2A-4

**Remarque :** N'utilisez pas de perceuse pour serrer les tire-fonds. Utilisez uniquement une clé à douille.

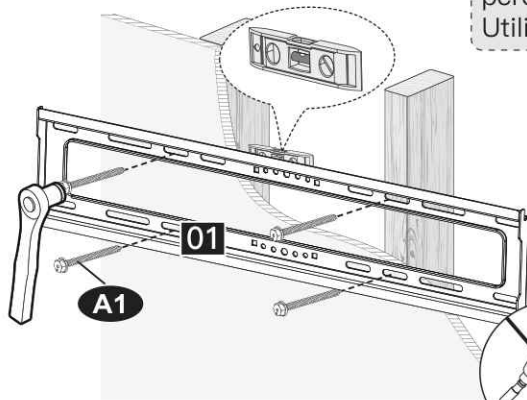

Installez la plaque murale à l'aide des tire-fonds [A1]. Serrez les tire-fonds [A1] et tirez-les fermement contre la plaque murale. **NE SERREZ PAS** trop les tire-fonds [A1].

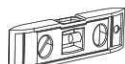

Niveau  
(Non inclus)



1/2 pouce (13mm)  
Clé à douille  
(Non inclus)

## Étape 2B Option de mur en béton massif

### **! AVERTISSEMENT:**

N'utilisez pas de perceuse pour serrer les tire-fonds ! Utilisez uniquement une clé à douille.

- Évitez les blessures corporelles ou les dommages matériels potentiels ! NE SERREZ PAS trop les tire-fonds [A1]. Serrez les tire-fonds [A1] et tirez-les fermement contre la plaque murale.
- Assurez-vous que la plaque murale est bien fixée au mur avant de passer à l'étape suivante.
- Montez la plaque murale directement sur la surface en béton sans aucun revêtement.
- L'épaisseur du mur en béton doit dépasser 5,5 pouce (140 mm).



Ancre de mur  
**A2**

### 2B-1

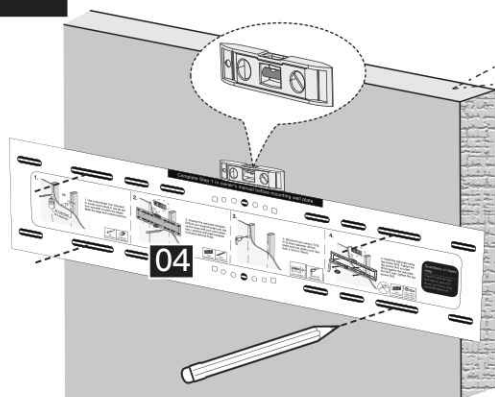

Wall Thickness  
≥ 5.5 in  
(140mm)

Positionnez le modèle de plaque murale [04] à la hauteur souhaitée. Mettez à niveau le modèle de plaque murale [04] et marquez les emplacements des avant-trous.



### 2B-2

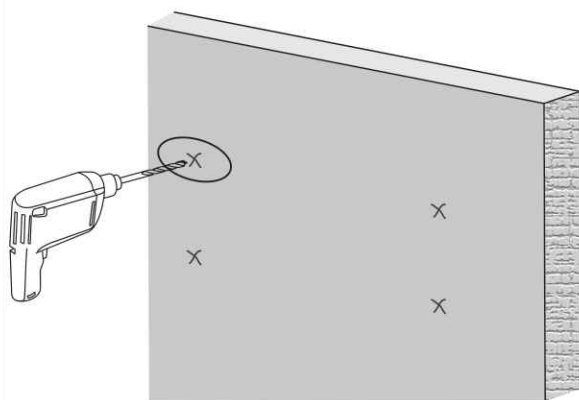

Percez 4 trous pilotes à l'aide d'un foret de 3/8 pouce (10 mm) de diamètre. Assurez-vous que la profondeur n'est pas inférieure à 3 pouce (75 mm).

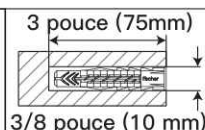
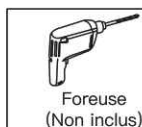

2B-3



Marteau-piqueur  
(Non inclus)

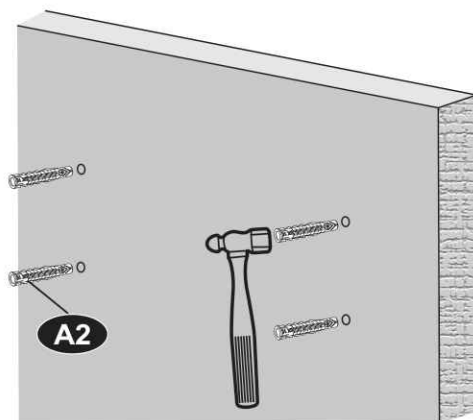

Utilisez le marteau pour enfoncer les ancrages [A2] dans le mur.  
Veillez à ce que les ancrages [A2] soient posés au ras de la surface  
du béton.

2B-4

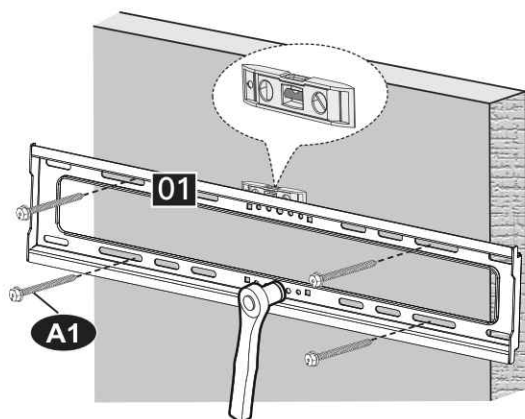

Installez la plaque murale [01] à l'aide des tire-fonds [A1].  
Serrez les tire-fonds [A1] et tirez-les fermement contre la  
plaque murale [01]. **NE SERREZ PAS** trop les tire-fonds [A1].

**Remarque :** N'utilisez pas de  
perceuse pour serrer les tire-fonds.  
Utilisez uniquement une clé à douille.

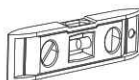

Niveau  
(Non inclus)



1/2 pouce (13mm)  
Clé à douille  
(Non inclus)

## Étape 3 Fixer le téléviseur sur la plaque murale

Pour accrocher le téléviseur sur la plaque murale

1. Accrochez le téléviseur à la plaque murale à l'aide des supports [02] et [03].
2. Appuyez doucement sur le bas du téléviseur vers le mur jusqu'à ce que vous entendiez les verrous de sécurité se mettre en place des deux côtés du support.

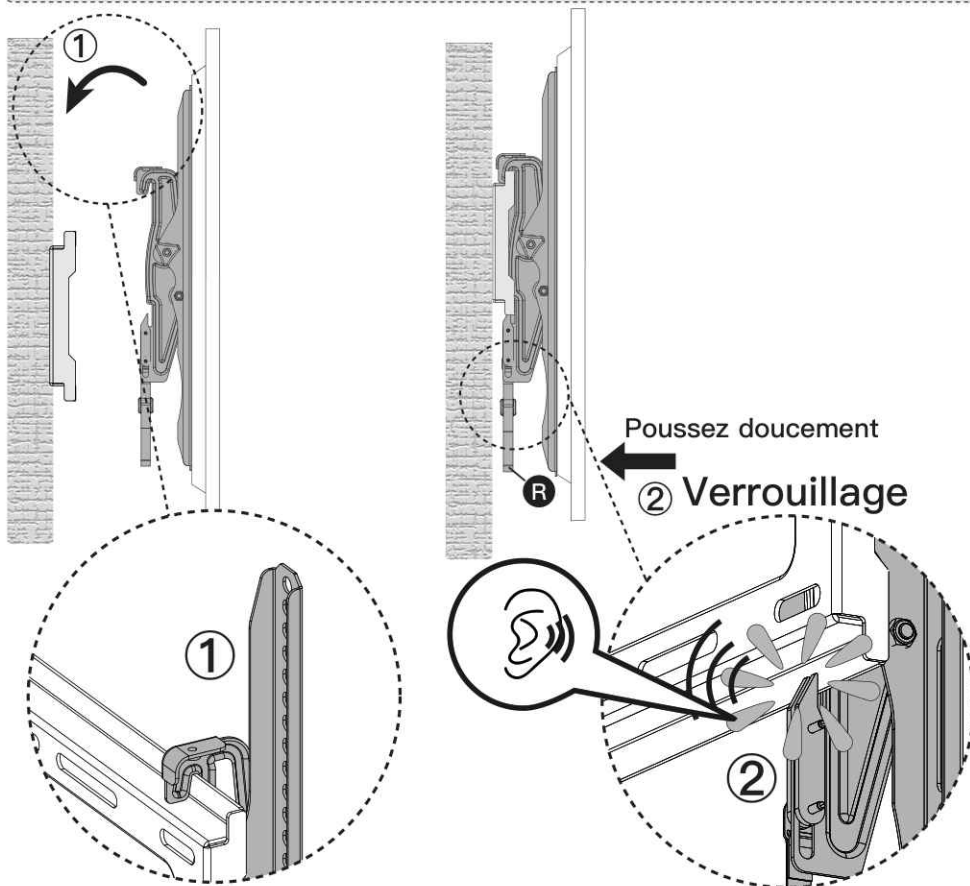

**LOURD!** vous aurez peut-être besoin d'aide pour cette étape.

Attention : pour éviter toute blessure potentielle et tout dommage matériel, deux personnes doivent aider à retirer le téléviseur du support.

1. Vérifiez que tous les câbles sont débranchés à l'arrière du téléviseur et que le téléviseur est débranché du mur.
2. Tout en exerçant une légère pression sur l'avant du téléviseur vers le mur, tirez sur les sangles de sécurité jusqu'à ce qu'elles soient complètement désengagées.
3. Tout en maintenant les sangles en position désengagée, éloignez le bas du téléviseur du mur et soulevez le téléviseur de la plaque murale.

## Matériel fourni pour l'étape 4



3/16 pouce (5mm)  
Clé hexagonale x1

## Étape 4 Réglage

### Réglage de l'inclinaison

1. Utilisez les boutons de tension sur les côtés des Support TV pour permettre le réglage du téléviseur dans la position souhaitée.
2. Après tout réglage, resserrez toujours les boutons de tension pour maintenir le téléviseur en place et éviter tout mouvement indésirable.

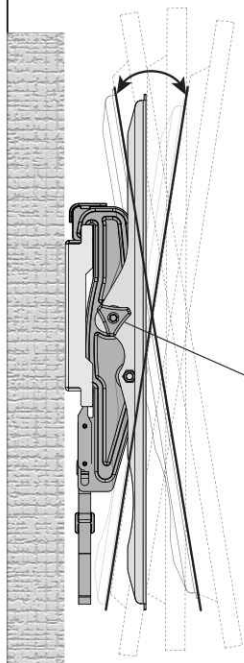

### ⚠ ATTENTION!

Veillez ne pas trop serrer ou trop desserrer les boutons.

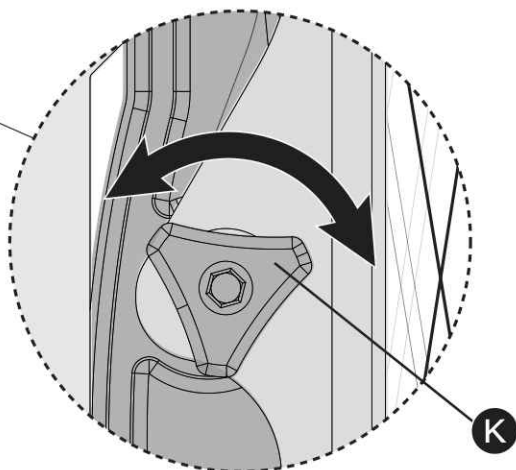

3/16 pouce (5mm)  
Clé hexagonale

## INFORMACIÓN IMPORTANTE DE SEGURIDAD

**⚠ ¡PELIGRO!** Por favor, lea cuidadosamente todas las instrucciones antes de realizar la instalación. Si no entiende las instrucciones o tiene alguna duda o consulta, póngase en contacto con nuestra línea de asistencia técnica llamando al (877) 419-7832, o escribiendo al servicio de atención al cliente en [support@ergoav.com](mailto:support@ergoav.com).

**⚠ PRECAUCIÓN:** El uso con productos más pesados que los pesos máximos indicados puede causar inestabilidad causando posibles lesiones.

- No utilice este producto con ningún fin que no sea el especificado explícitamente en este manual. No supere la capacidad de peso. No nos hacemos responsables de posibles daños o lesiones causados por un montaje incorrecto, errores de ensamblaje o uso inadecuado.
- Este producto está diseñado para su uso en montantes de madera y en paredes de hormigón sólido. – NO instalar solo en placa de yeso.
- La pared debe ser capaz de soportar cuatro veces el peso del televisor y del soporte juntos.
- Utilice este sistema de montaje sólo para el uso previsto, tal como se describe en estas instrucciones. No utilice accesorios no recomendados por el fabricante.
- No lo utilice en el exterior.
- Coloque los cables de forma apropiada para evitar daños mecánicos.
- **GUARDE ESTAS INSTRUCCIONES.**

## Límites de peso



Si su televisor excede el peso, no utilice este producto.

### ⚠ ADVERTENCIA

NO exceda el peso máximo indicado. Este módulo para televisor solo debe usarse dentro de los pesos máximos indicados. Si se usa con productos que exceden los pesos máximos indicados es posible que se produzca una falla en el módulo para televisor y sus accesorios, posiblemente provocando daños y/o lesiones.

## Revise el patrón VESA de la TV antes de la instalación

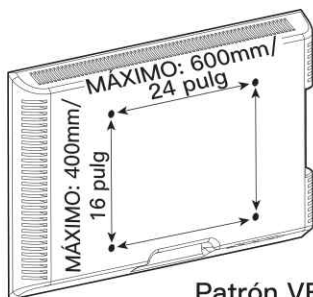

100 mm ≈ 4 pulg  
200 mm ≈ 7 7/8 pulg  
400 mm ≈ 15 3/4 pulg  
600 mm ≈ 23 5/8 pulg

Patrón VESA mínimo: 200mmx100mm/8 pulgx4 pulg

Si su televisor VESA mide más de 600x400 mm/24x16 pulg o menos que VESA 200x100mm/8x4 pulg, este soporte de televisor NO es compatible.

Si este soporte NO es compatible, póngase en contacto con nuestra línea de asistencia técnica al (877) 419-7832 o con el servicio de atención al cliente en [support@ergoav.com](mailto:support@ergoav.com).

## Herramientas necesarias (no incluidas)



Detector de vigas



Punzón



Cinta métrica



Lápiz



Taladro



Nivel



7/32 pulg (5.5mm)  
Broca para madera



1/2 pulg (13mm)  
Llave de tubo



Destornillador  
Philips

(Necesaria para las instalaciones en hormigón)



3/8 pulg (10mm)  
Broca para hormigón



Martillo

## Inspeccione la construcción de su pared

**PRECAUCIÓN**

NO instalar solo en placa de yeso

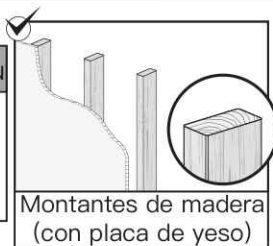

Montantes de madera (con placa de yeso)

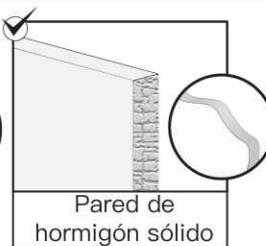

Pared de hormigón sólido

Si no está seguro sobre las condiciones de construcción de su pared, póngase en contacto con nuestra línea de asistencia técnica en el (877) 419-7832 o con el servicio de atención al cliente en [support@ergoav.com](mailto:support@ergoav.com).

## Piezas y herramientas provistas

**ADVERTENCIA:** Este producto contiene piezas pequeñas que pueden representar un riesgo de atragantamiento si se ingieren.

Antes de iniciar el montaje, compruebe que todas las piezas estén incluidas e intactas. No utilice piezas dañadas o defectuosas. Si necesita piezas de repuesto, póngase en contacto con nuestra línea de asistencia técnica al (877) 419-7832 o con el servicio de atención al cliente en [support@ergoav.com](mailto:support@ergoav.com)

• Tenga en cuenta lo siguiente: Es posible que no necesite usar todos los herrajes incluidos en este envase.

## Piezas y herrajes suministrados para el paso 1

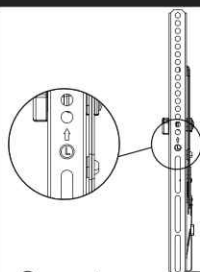

Soporte para TV izquierdo

**02** x1

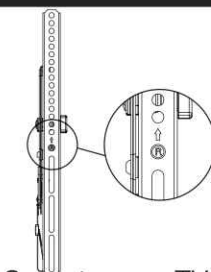

Soporte para TV derecho

**03** x1

### Espaciadores

**Nota:** Los espaciadores se muestran en tamaño real.

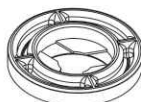

L2.5mm

**F1** x8

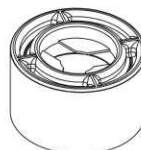

L10mm

**F2** x4



L22mm

**F3** x4

Arandela

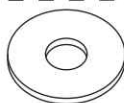

M4/M5

**B1** x4

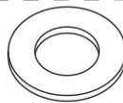

M6/M8

**B2** x4

## Pernos del televisor [Su televisor solo admite uno de los tamaños de perno]

**Nota:** Los pernos se muestran en tamaño real

**M4**



M4x12mm

**C1** x4



M4x30mm

**C2** x4

**M6**

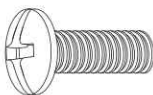

M6x15mm

**D1** x4

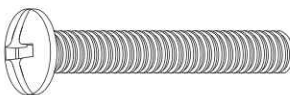

M6x35mm

**D2** x4

**M8**

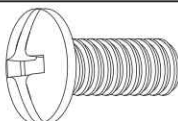

M8x15mm

**E1** x4

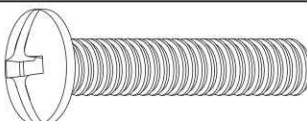

M8x35mm

**E2** x4

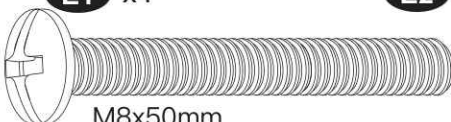

M8x50mm

**E3** x4

## Paso 1 Asegure los soportes de la TV a la TV

### Seleccione el perno para el TV

Su televisor solo admite uno de los tamaños de perno.

M4 M6 M8

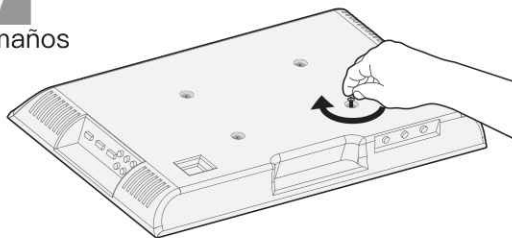
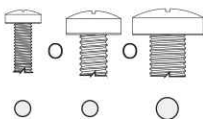

Longitud del perno: Compruebe que la rosca encaje correctamente con los pernos o la las combinaciones de pernos/espaciador. Se recomienda enganchar las roscas con 5 vueltas como mínimo.

- Si es demasiado corto, no soportará el TV.
- Si es demasiado largo, hará daños al TV.

**Nota:** No ajuste los pernos del televisor en exceso para no dañarlo.

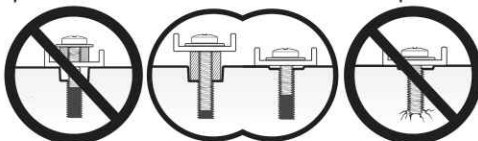

Demasiado corto

Correcto

Demasiado largo

**Nota:** Al utilizar espaciadores, es importante tener en cuenta que se pueden utilizar apilados. Si tiene alguna dificultad para comprender el modo de instalación de los pernos o espaciadores del televisor, póngase en contacto con nuestra línea de asistencia técnica al (877) 419-7832 o con el servicio de atención al cliente en support@ergoav.com.

## Piezas necesarias si tiene un televisor como el que se muestra a continuación

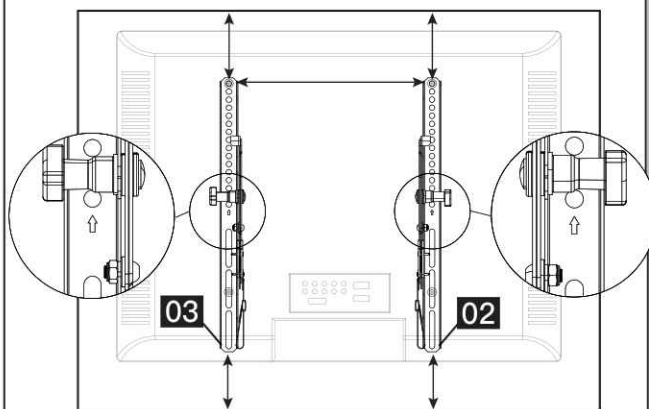
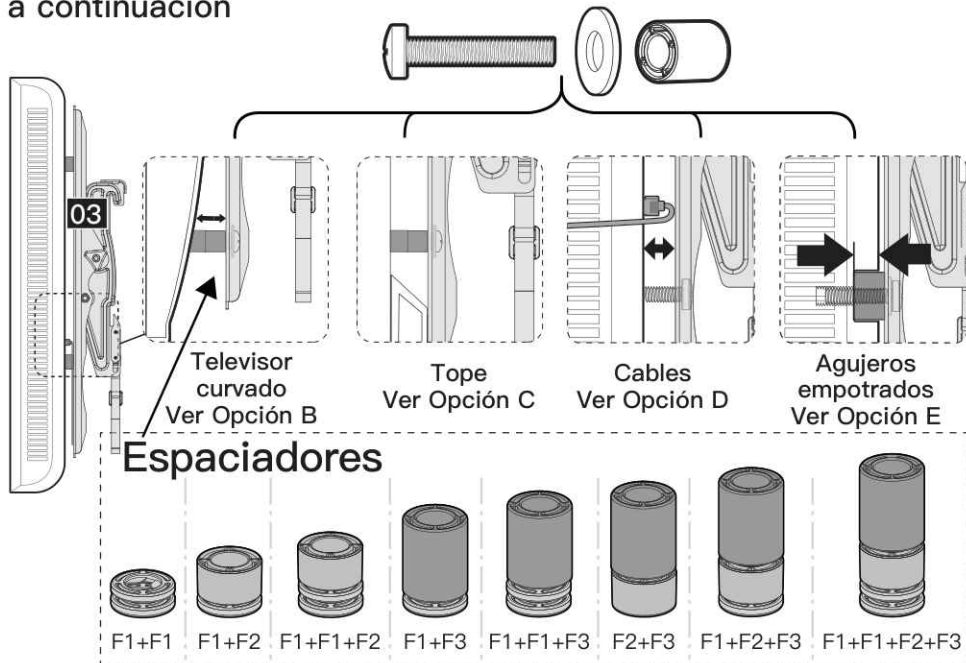

**⚠ PRECAUCIÓN:** Cuando fije los soportes para TV a la parte posterior del televisor, asegúrese de que las flechas hacia arriba apunten a la parte superior del televisor y estén igualmente centradas en la parte posterior del mismo.

**⚠ NOTA:** Las ubicaciones de los agujeros para perno de su televisor pueden variar según el diseño del televisor de los fabricantes. Solo ilustramos algunas ubicaciones posibles de dichos agujeros de los pernos.

## Opción A (Para televisores con la parte trasera plana)

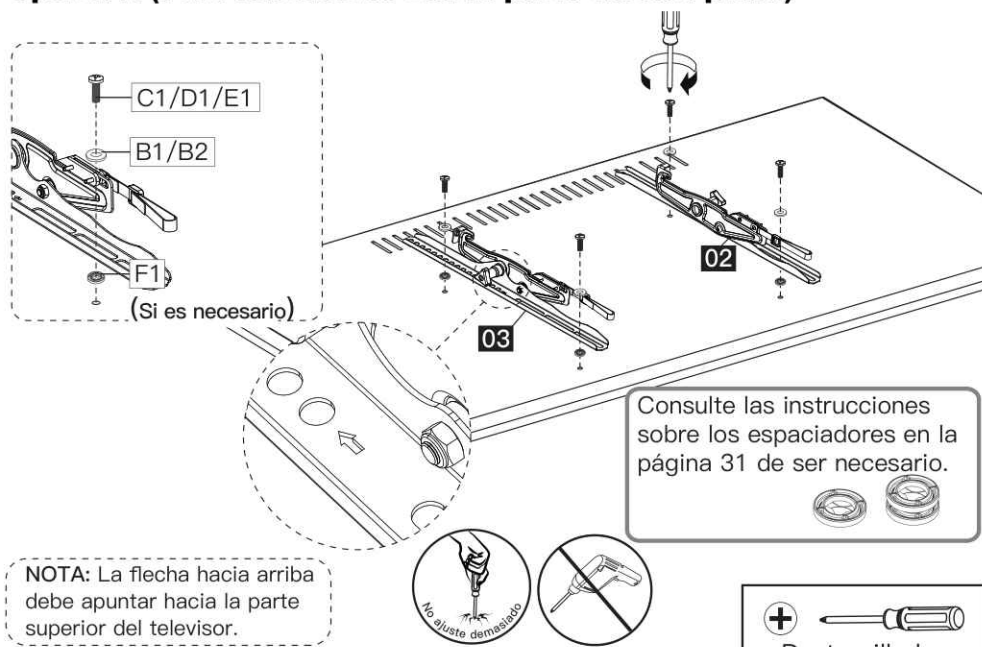

## Opción B (Para televisores con la parte trasera redondeada)

Los espaciadores deben ser lo suficientemente altos para que la curva de la parte posterior del televisor no interfiera con la placa de montaje.

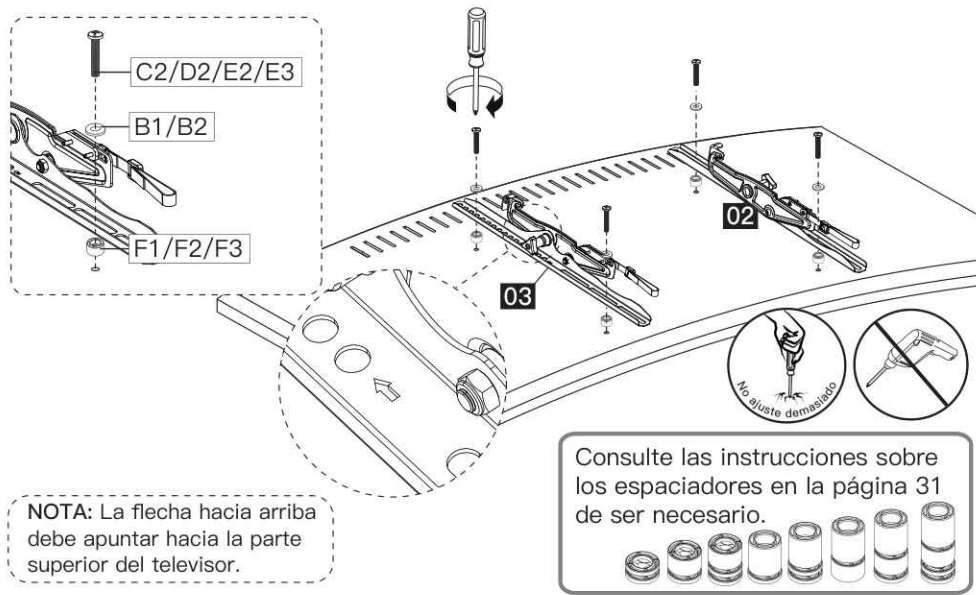

### Opción C (Para televisores con parte trasera saliente)

Los espaciadores deben estar lo suficientemente altos para que no haya espacios entre el Soporte para TV y el bulto en la parte posterior del Televisor.

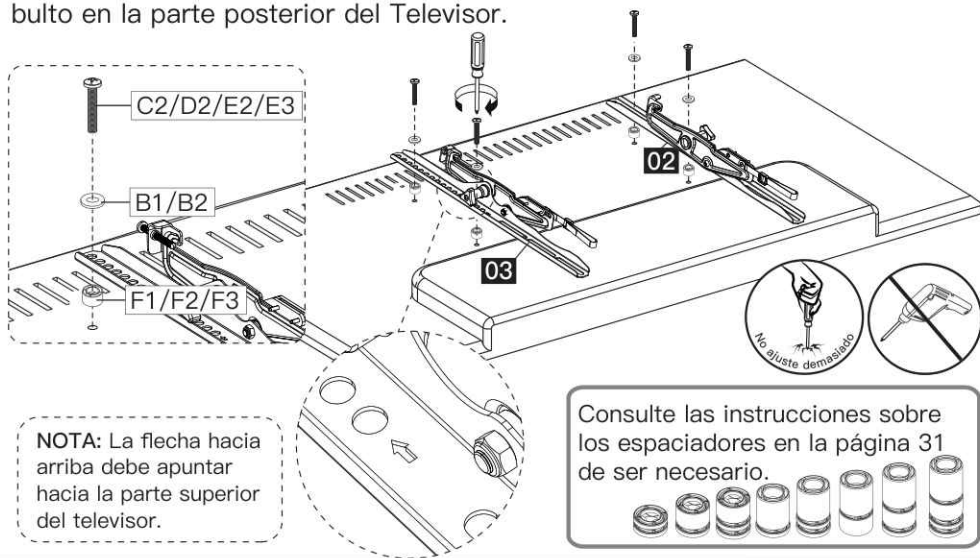

### Opción D (para televisor con interferencia de cables)

Para la interferencia de cables, utilice los espaciadores [F1], [F2] y [F3] para crear un espacio extra entre el televisor y los soportes para TV.

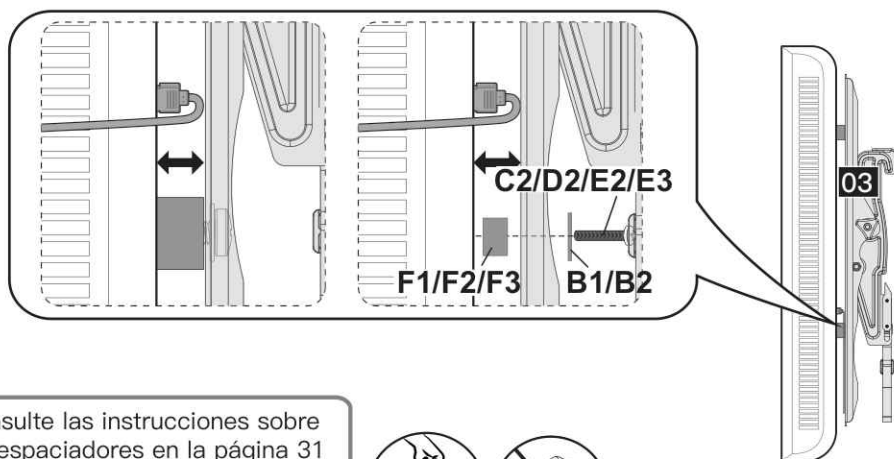

## Opción E (Para agujeros empotrados)

El espaciador debe rellenar los agujeros empotrados en la base del televisor para que los soportes para TV estén lo más cerca posible del mismo.

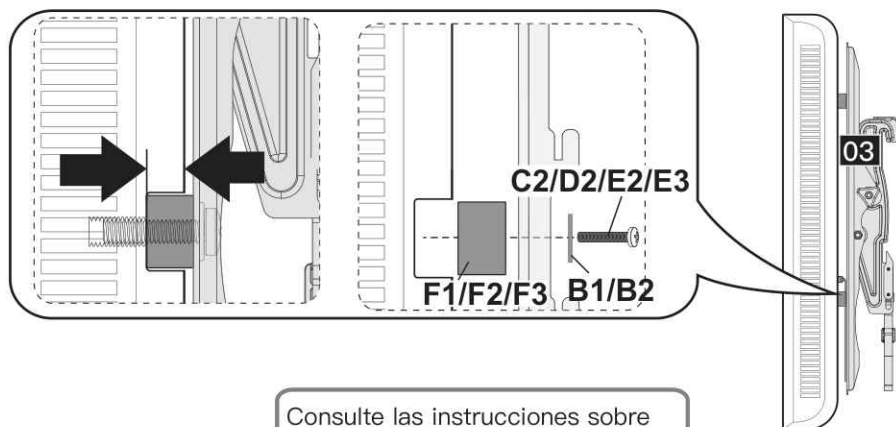

Consulte las instrucciones sobre los espaciadores en la página 31 de ser necesario.



## Piezas y herrajes suministrados para el paso 2

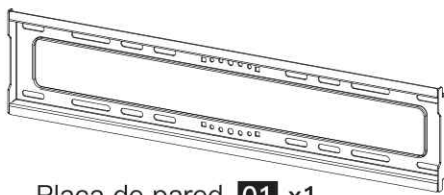

Placa de pared **01** x1

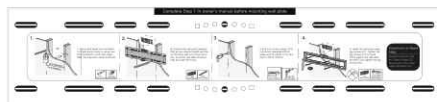

Plantilla de pared **04** x1

**Nota:** El tornillo de retraso se muestra en tamaño real

**A1** x4

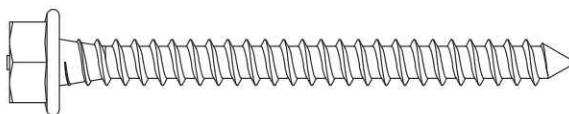

Tornillo de retraso  
5/16X2 3/4 pulg

**A2** x4

Anclas de  
pared  
10X60mm

**! PRECAUCIÓN!**

Este taco es SOLO para paredes de hormigón. No los utilice en paredes de yeso o madera.



## Paso 2 Fije la placa de pared [01] a la pared

Para la instalación en montantes de madera, siga el PASO 2A.

Para la instalación de hormigón, siga el PASO 2B.

## Paso 2A Opción para montantes de madera

### **! ADVERTENCIA:**

No utilice un taladro para ajustar los tornillos de retraso. Utilice únicamente una llave de tubo.

¡Evite posibles lesiones o daños a objetos de su propiedad! No ajuste demasiado los tornillos de retraso [A1]. Ajuste los tornillos de retraso [A1] con firmeza contra la placa de pared.

**NO UTILICE EL TACO [A2] PARA ESTE PASO.**

Asegúrese de que la placa de pared esté bien sujeta a la pared antes de continuar con el siguiente paso.

- Tamaño nominal del montante de madera: común 2 x 4 pulg (51 x 102 mm).
- Debe revisar el centro del montante.



### 2A-1

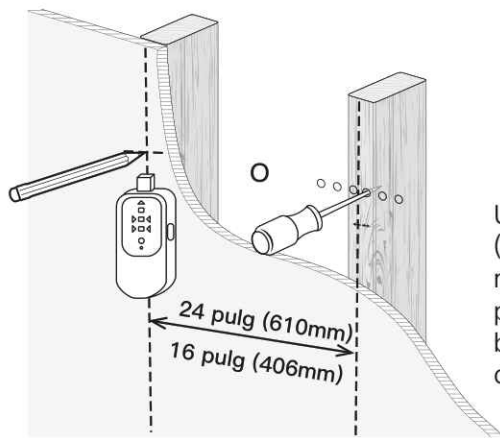

Utilice un localizador de montantes (no incluido) para localizar los montantes de madera o utilice un punzón (no incluido) para revisar los bordes y el centro. Marque los bordes y el centro.

## 2A-2

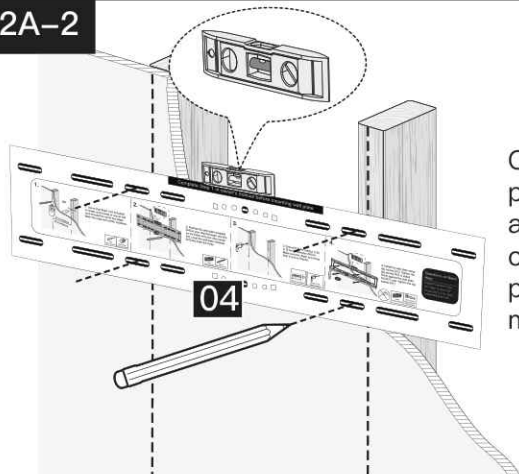

Coloque la plantilla de placa de pared [04] a la altura deseada y alinee los agujeros con la línea central de los montantes. Nivele la plantilla de placa de pared [04] y marque los agujeros.

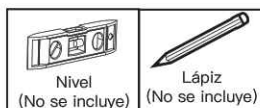

## 2A-3

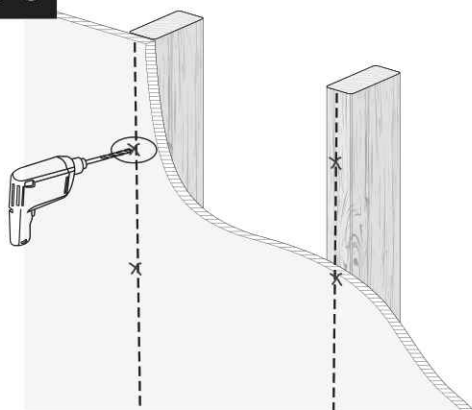

Taladre los agujeros provisionarios con una broca de 7/32 in (5,5 mm) de diámetro. Asegúrese de que la profundidad no sea inferior a 2 3/4 in (70 mm).

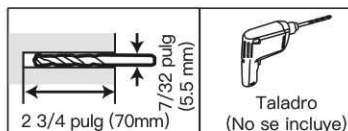

## 2A-4

**Nota:** No utilice un taladro para ajustar los tornillos de retraso. Utilice únicamente una llave de tubo.

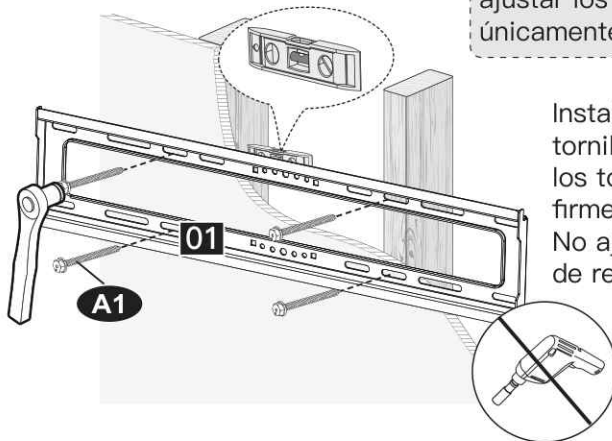

Instale la placa de pared con tornillos de retraso [A1]. Ajuste los tornillos de retraso [A1] con firmeza contra la placa de pared. No ajuste demasiado los tornillos de retraso [A1].

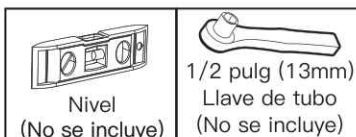

## Paso 2B Opción de pared de hormigón sólido

### **! ADVERTENCIA:**

No utilice un taladro para ajustar los tornillos de retraso. Utilice únicamente una llave de tubo.

- ¡Evite posibles lesiones o daños a objetos de su propiedad! No ajuste demasiado los tornillos de retraso [A1]. Ajuste los tornillos de retraso [A1] con firmeza contra la placa de pared.
- Asegúrese de que la placa de pared esté bien sujeta a la pared antes de continuar con el siguiente paso.
- Monte la placa de pared directamente sobre la superficie de hormigón sin ningún tipo de recubrimiento.
- El grosor de la pared de hormigón debe ser mayor a 5,5 pulg (140 mm).



### 2B-1

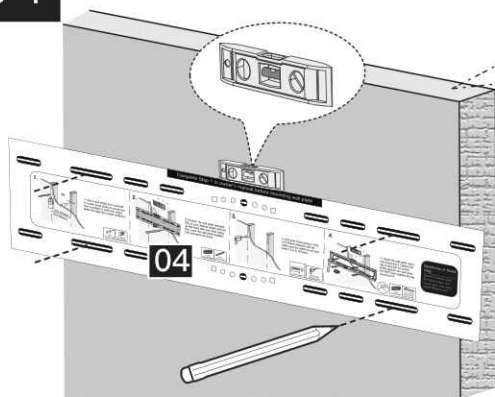

Wall Thickness  
≥5.5 in  
(140mm)

Coloque la Plantilla de Placa de Pared [04] a la altura deseada. Nivele la Plantilla de Placa de Pared [04] y marque las ubicaciones de los agujeros provisionarios.

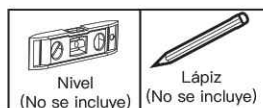

Nivel  
(No se incluye)

Lápiz  
(No se incluye)

### 2B-2

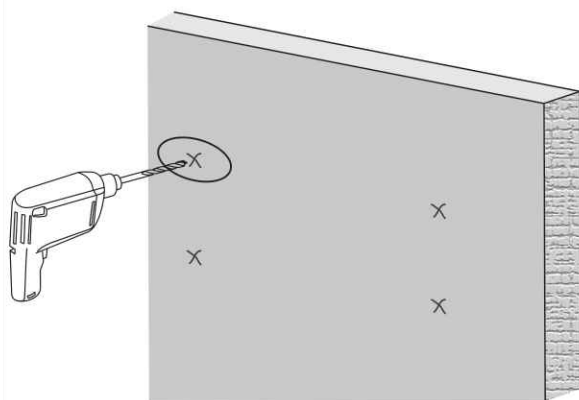

Taladre 4 agujeros piloto con una broca de 3/8 pulg (10 mm) de diámetro. Asegúrese de que la profundidad no sea inferior a 3 pulg (75mm).

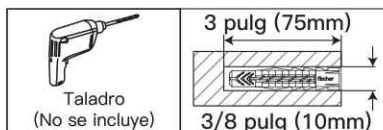

Taladro  
(No se incluye)

3 pulg (75mm)  
3/8 pulg (10mm)

## 2B-3



Martillo  
(No se incluye)

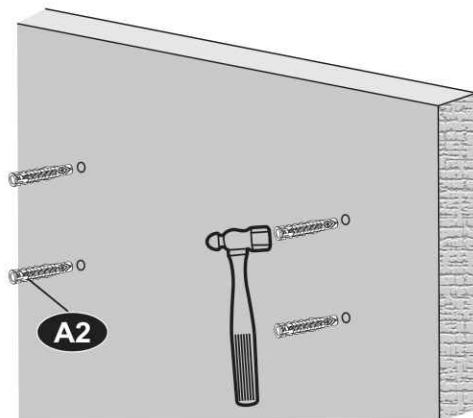

Utilice el martillo para golpear los Anclas de pared [A2] en la pared. Asegúrese de que los Anclas de pared [A2] se asienten a ras de la superficie de hormigón.

## 2B-4

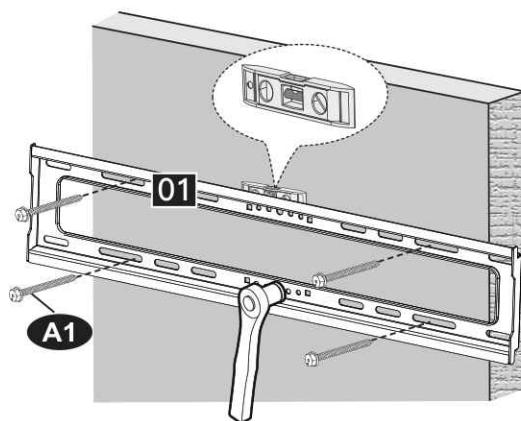

Instale la placa de pared [01] con los tornillos de retraso [A1]. Ajuste los tornillos de retraso [A1] para que queden bien sujetos a la placa de pared [01]. No ajuste demasiado los tornillos de retraso [A1].

**Nota:** No utilice un taladro para ajustar los tornillos de retraso. Utilice únicamente una llave de tubo.

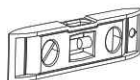

Nivel  
(No se incluye)





1/2 pulg (13mm)  
Llave de tubo  
(No se incluye)

### Paso 3 Fije el televisor en la placa de pared

Para colgar el televisor en la placa de pared

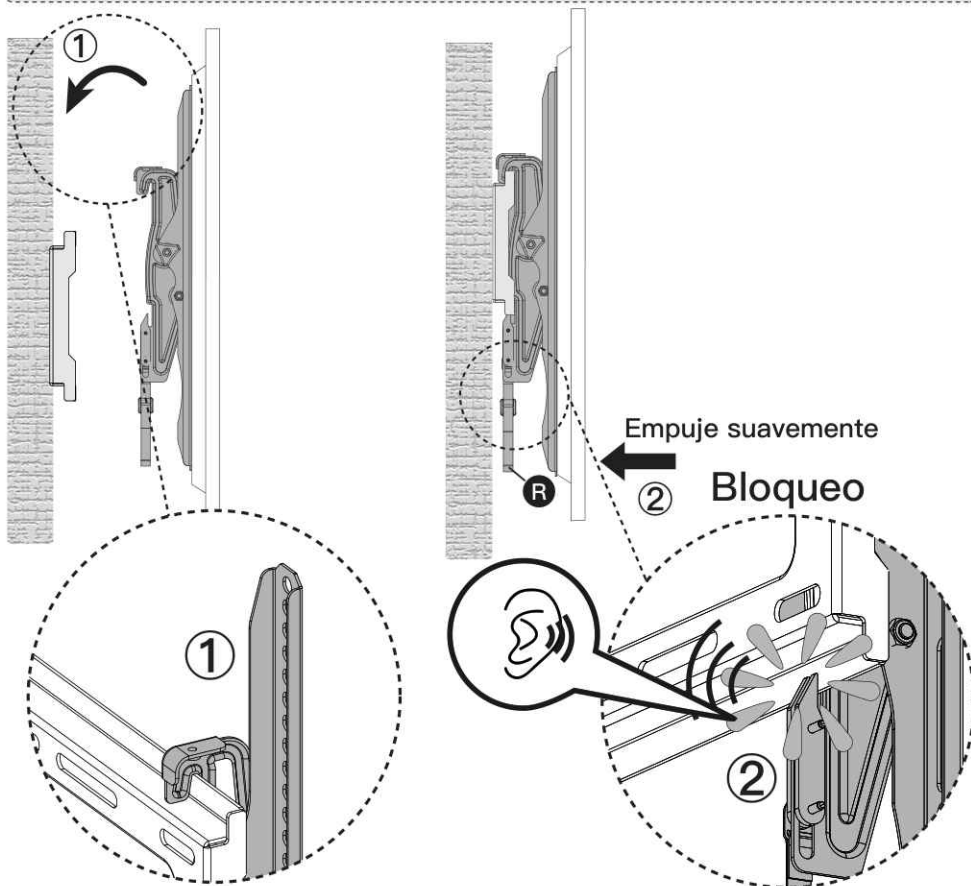
1. Cuelgue el televisor con los soportes [02] y [03] en la placa de pared.
2. Presione suavemente la parte inferior del televisor hacia la pared hasta que oiga el "clic" de las cerraduras de seguridad en ambos lados del soporte.



  ¡OBJETO PESADO! Es posible que necesite asistencia en este paso.

**Precaución:** para evitar posibles lesiones y daños materiales, el televisor debe ser sacado del soporte por dos personas.

1. Revise que todos los cables estén desconectados de la parte posterior del televisor y que éste esté desenchufado de la pared.
2. Mientras presiona suavemente la parte delantera del televisor hacia la pared, tire las correas de seguridad hacia abajo hasta que se desenganchen por completo.
3. Mientras mantiene las correas desenganchadas, aleje la parte inferior del televisor de la pared y levántelo de la placa de pared.

## Hardware suministrado para el paso 4



3/16 pulg (5mm)  
Llave Allen

x1

## Paso 4 Ajuste

### Ajuste de la inclinación

1. Utilice las perillas de tensión en los lados de los Soportes para TV para ajustar el televisor a la posición deseada.
2. Después de realizar cualquier ajuste, vuelva a ajustar las perillas de tensión para mantener el televisor en su sitio y evitar movimientos no deseados.

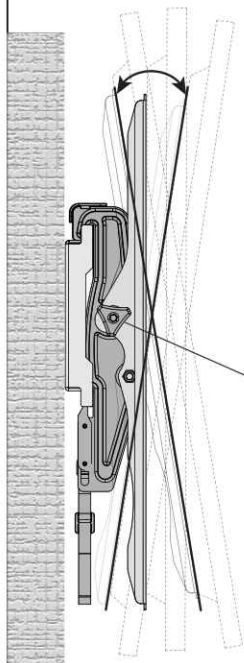

### **⚠ PRECAUCIÓN!**

Mo ajuste ni afloje las perillas en exceso.

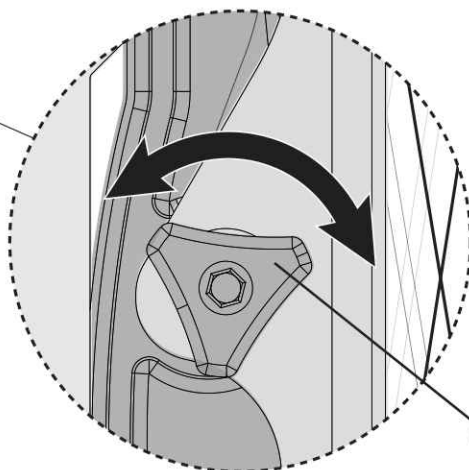

**K**



3/16 pulg (5mm)  
Llave Allen









At ErgoAV, we strive to provide the highest valued products.  
We want to support your purchase.  
If you have questions, concerns,  
or feedback please let us know!

ErgoAV Customer Care  
Phone (877) 419-7832 M-F 8am to 8pm CST  
[support@ergoav.com](mailto:support@ergoav.com)

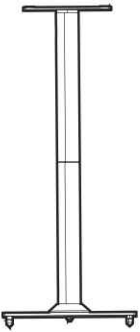

Speaker Stands

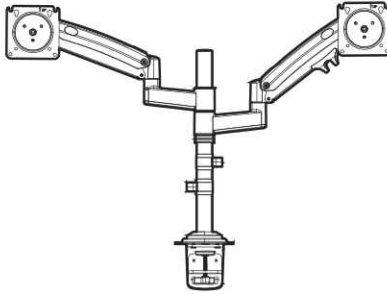

Computer Monitor Mounts

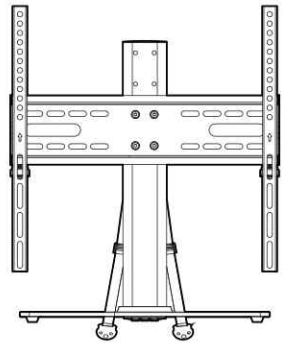

TV Stand

9501 Louisiana Ave N, #200, Brooklyn Park, MN 55445  
[WWW.ERGOAV.COM](http://WWW.ERGOAV.COM)